

AIRCRAFT DESIGN AND SYSTEMS GROUP (AERO)

Aircraft Cabin Ventilation in the Corona Pandemic – Legend and Truth

Dieter Scholz Hamburg University of Applied Sciences

Hamburg Aerospace Lecture Series (Aero Lectures)

DGLR, RAeS, VDI, ZAL, HAW Hamburg

Online, 24 June 2021

<https://doi.org/10.5281/zenodo.5356568>

<https://doi.org/10.48441/4427.250>



Legend or **Truth**

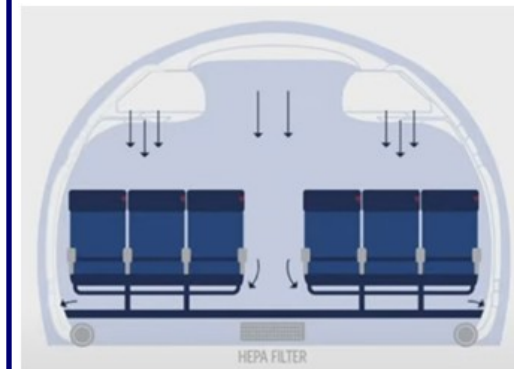

Delta

Abstract

Purpose – Reach awareness that the aviation industry (manufacturers, airlines, organizations) is lying about cabin ventilation on board of passenger aircraft.

Approach – Industry information published during the corona pandemic is collected from the Internet and set against scientific evidence.

Findings – HEPA filters in aircraft do not produce cabin air "as clean as [in] a hospital operating theatre". Viruses and other substances like CO₂ are generated in the cabin and need to be washed out. Their concentration follows from their source strength and the ventilation air flow rate. Aircraft cabin air is not "fully renewed in 2 to 3 minutes". It takes several such air changes to reach 1% of the initial concentration. The air change rate is not even relevant for the concentration of e.g. viruses or CO₂ in the cabin. The "air flow in the cabin" is not "only flow from top to bottom". The air is mixed within several rows and beyond.

Research limitations – Neither the industry campaign nor the literature on (aircraft cabin) ventilation is fully explored. Only examples are given to illustrate how the aviation industry deceived politics and the public for their economic advantage.

Practical implications – Learning from the past to be prepared for similar manipulation in the future. Importance to question any given information – also this one.

Social implications – The discussion opens up the topic beyond aviation expert circles.

Originality – Not much comparable information is given by other authors.

Aircraft Cabin Ventilation in the Corona Pandemic – Legend and Truth

Independent Project at HAW Hamburg: "Flying During the Corona Pandemic"



- Press Releases, **Memos**: 8 documents.
- **Media production** with my contribution:
 - Radio / TV: 14
 - Print: 18
 - Online: 26
 - Own Video: 1

<http://corona.ProfScholz.de>

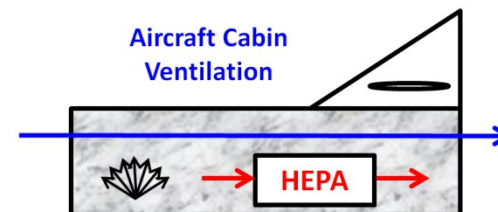

Aircraft Cabin Ventilation in the Corona Pandemic – Legend and Truth

Table of Content

- What's the Problem?
- Air Conditioning System (ATA 21)
- Pneumatic System (ATA 36)
- Turbofan Engine – Bleed Air Extraction
- **Cabin Ventilation Theory**
- **Legend** or **Truth**?
- Truth Decay?
- Summary
- Contact

What is the Problem?

What is the Problem?

Simple Basic Thoughts Help to Structure the Problem

- **Problem 1: A fast and global spread of the virus (SARS-CoV-2) by aircraft!**
 - Fact: The virus spread very quickly from Wuhan over continents in all parts of the world – not by ship, not by train, but **by airplane**. No one denies this.
 - As such, world wide mobility is boon and bane (German: Segen und Fluch)
 - Pandemics happened before, but this one resulted in a necessary (partial) **shut-down of aviation**.
 - **Governments** (to some extend) **and passengers made the shut-down a reality**.
 - **Organizations of the aviation industry worked with all their power against the shut-down**.
Understandable? Yes.
Responsible? No!
 - **Mitigation possibilities**: Screening, testing, quarantine, ... vaccination

Problem 1 is NOT the topic of this lecture, because

=> we know this is a problem,

=> this lecture has a technical focus.

What is the Problem?

Simple Basic Thoughts Help to Structure the Problem

- **Problem 2: Infections with a virus on board of passenger aircraft!**

- Compared with Problem 1, this is **the minor problem** of the two, because not every healthy passenger flying together with an ill person will get infected.
- Certainly, every additional ill person arriving at a flight destination is a threat to the region.
- Furthermore, it is not only about those who might get infected on board, but also about a further spread of the virus to family, friends, and the community. An infection on board can be the start of an exponential growth.
- We know about a **high risk of infection when ...**
 - 1.) **many people** are together **yes, the case on passenger aircraft!**
 - 2.) people are **close to each other** **yes, the case on passenger aircraft!**
 - 3.) people are together **for a long time** **yes, the case on long-range flights!**
 - 4.) people are **inside** (rather than outside) **yes, the case on passenger aircraft!**
 - 5.) **the room is badly ventilated** **This will be investigated in this presentation!**

Do not be misguided:

If it would turn out that the aircraft cabin is well ventilated, **infection risks 1.) to 4.) remain a cause of concern** for passengers flying.

Air Conditioning System

Air Conditioning System (ATA 21)

Boundary Conditions

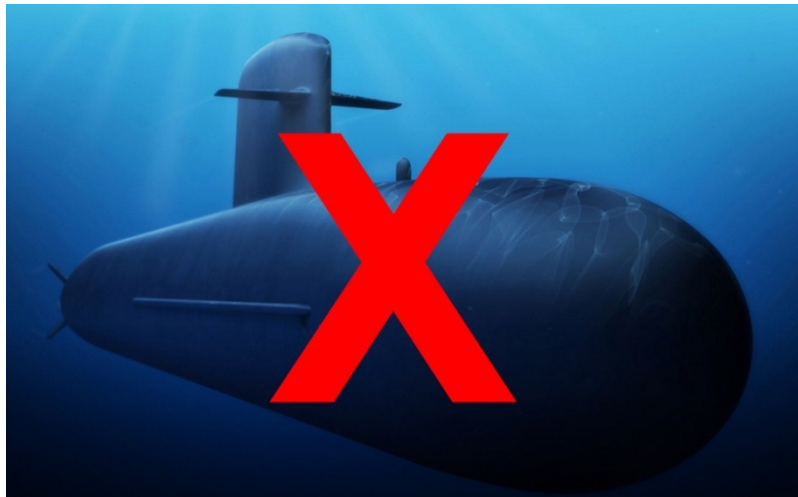
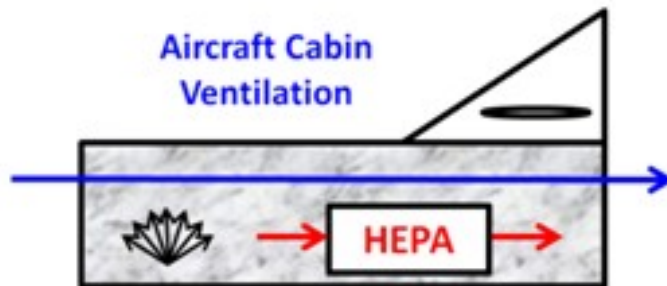

- **Atmospheric conditions**

- Oxygen content: 21%; independent of altitude.
- Pressure: 22% of sea level pressure.
- Temperature: -56 °C.

- **Aircraft is no submarine.**

Aircraft is open to the environment to draw air.

- Outside ("fresh") air can be used, but needs to be compressed. This requires energy.
- Compression delivers very high temperatures (based on thermodynamics).
- Cooling is necessary
 - 1.) to get the temperature down to normal levels
 - 2.) to cool the cabin, because the cabin experiences net heating due to passengers, system inefficiencies converted into heat, ...

Air Conditioning System (ATA 21)

Requirements

• Ventilation

- "the ventilation system must be designed to provide a **sufficient amount** of uncontaminated air" "to provide each occupant with an airflow that contains at least **0.25 kg of fresh air** [outside air] **per minute**" [CS-25.831\(a\)](#) "i.e. 10 cubic feet per minute of air at 8000 feet pressure altitude and at a cabin temperature of 24 °C" [AMC 25.831\(a\)\(1\)](#)
- "If an applicant proposes **not to provide the minimum required fresh airflow during the phases of flight** that use low power levels [**descent**], the applicant must show that the cabin air quality is not compromised during those flight phases" [AMC 25.831\(a\)\(2\)](#)
- "It should be demonstrated that the ventilation system continues to provide an acceptable environment in the passenger cabin and the cockpit for the brief period when the **air conditioning system is not operating [if it is off, e.g. on the ground]**" [AMC 25.831\(a\)\(3.b\)](#)
- "Finally, the period during which the aeroplane is operated with the air conditioning system **off** is intended to be of **short duration**" [AMC 25.831\(a\)\(3.e\)](#)
- "Where the air supply is supplemented by a recirculating system, it should be possible to stop the recirculating system and –
 - a. Still maintain the fresh air supply prescribed, and
 - b. Still achieve 1 [avoid contamination]." [AMC 25.831\(c\)](#)

Air Conditioning System (ATA 21)

Requirements

- **Temperature Control**
 - Cabin air temperatures are not defined in CS-25.
 - **Temperature control** is done **by ventilation** with (in most cases) cold air.
 - **Recirculation** allows to use "**more air**" at temperatures "**not as cold**" as required with less air.
 - Hence, **recirculation**
 - allows a more **even temperature distribution** in the cabin,
 - avoids cold drafts near passengers and **increases cabin comfort**.
 - "More air" (than required) could also be obtained from outside, but ...
 - **outside air needs** to be compressed (to cabin pressure), which requires **more energy**.
 - **recirculated air** only needs to be pumped (against pressure losses in tubes); it **saves energy**.
 - **Recirculated air** spreads air among all passengers (unlike outside air), hence the **need of filtration**.
- **Pressure Control**

"provide a cabin pressure altitude of not more than 8000 ft" [CS-25.841\(a\)](#)
- **(Moisture Control)**

Pressure and moisture control are not the topic of the lecture. Requirements are not further detailed.

Air Conditioning System (ATA 21)

Overview

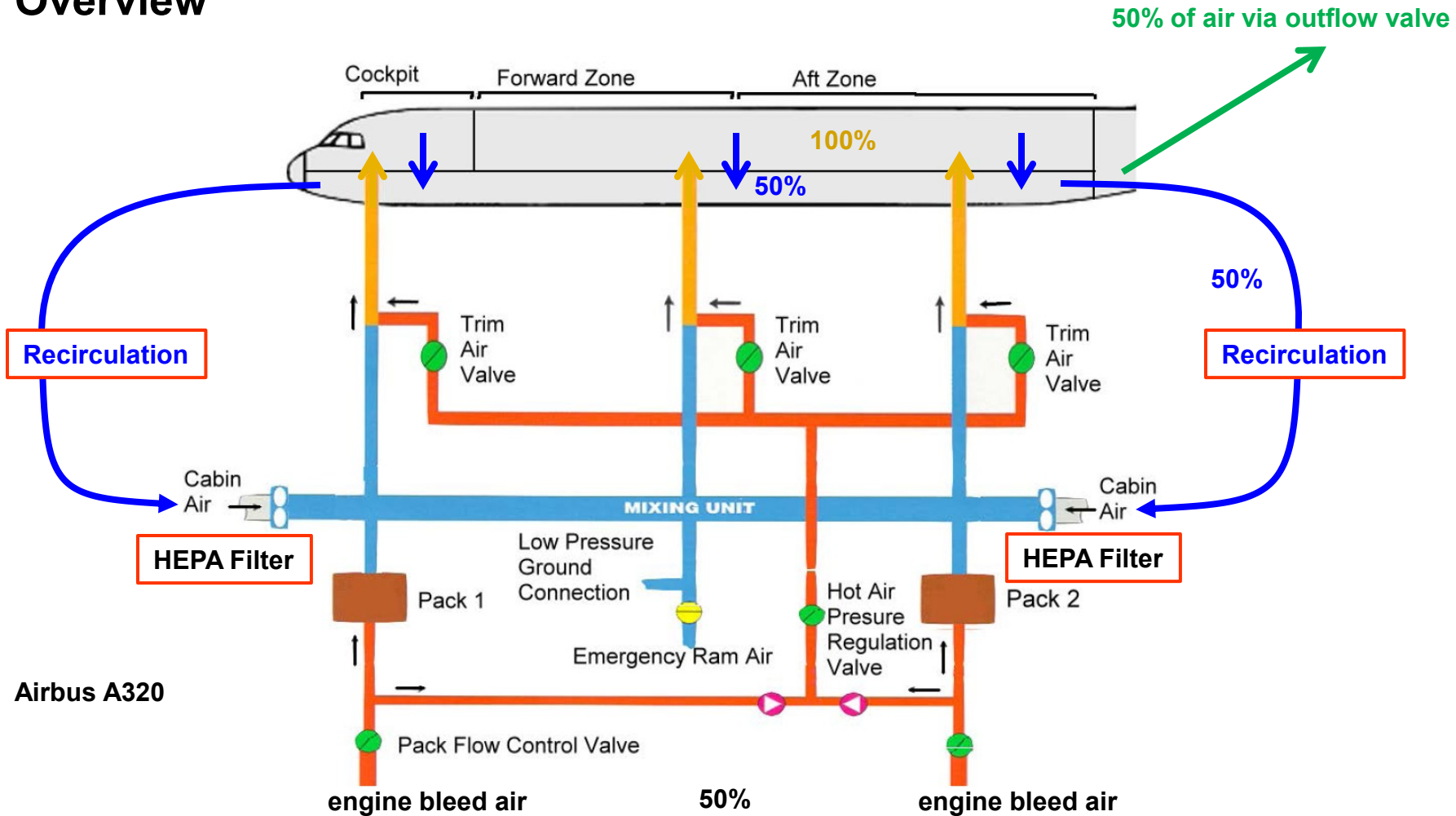

Airbus A320

Air Conditioning System (ATA 21)

Overview – Simplified Version

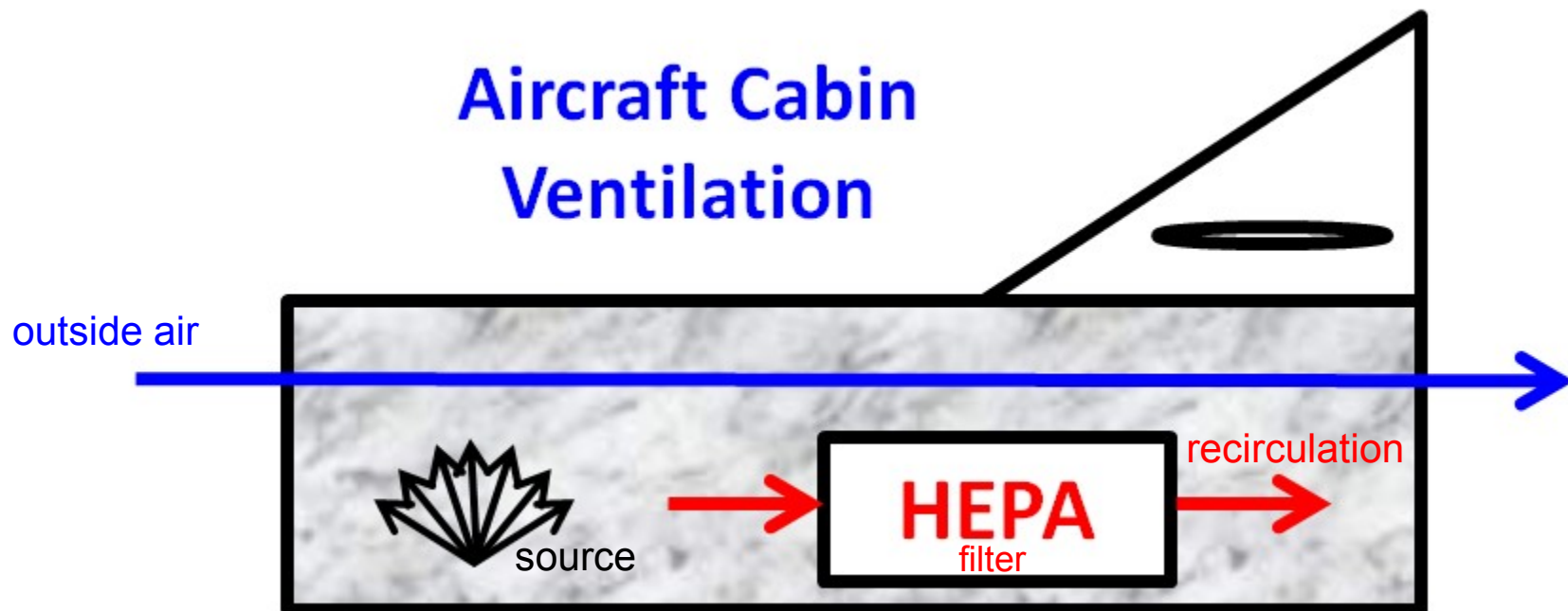

Air Conditioning System (ATA 21)

Air Distribution – Supply and Riser Ducts

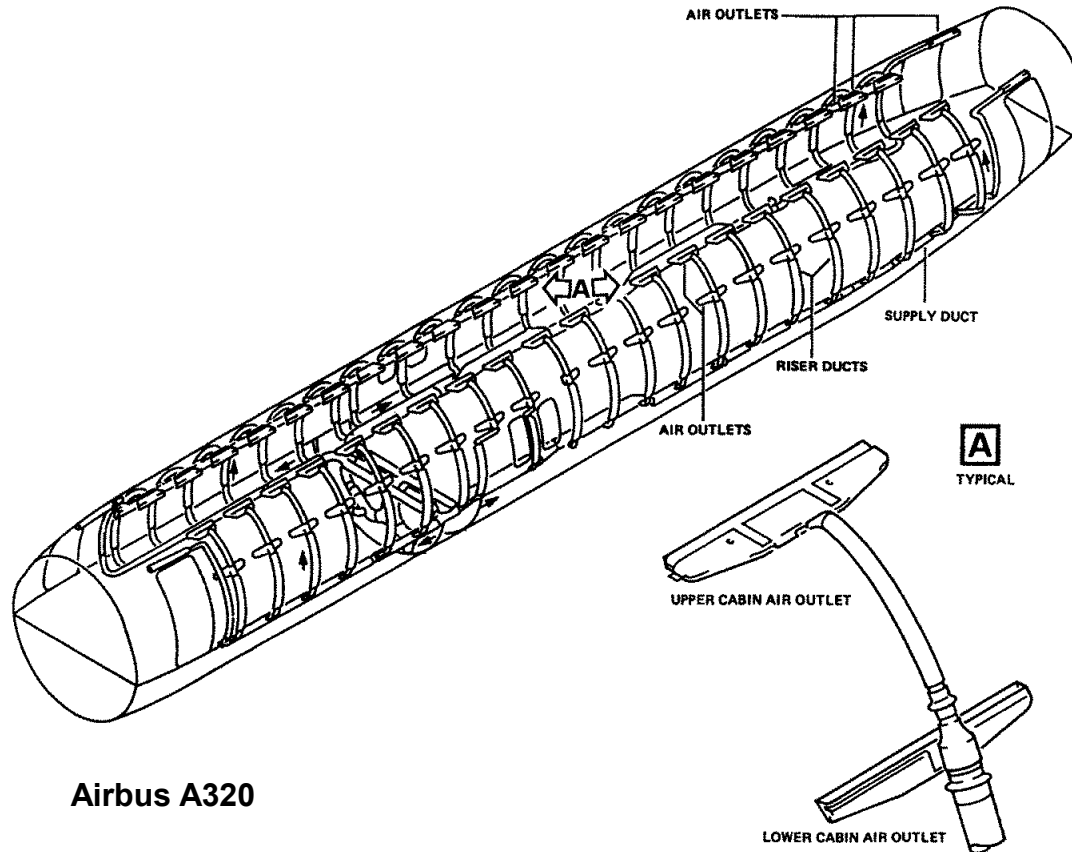

Airbus A320



Air Conditioning System (ATA 21)

Cabin Air Contamination – Traces After Years of Aircraft Operation

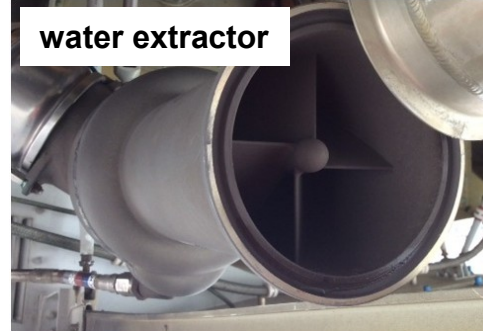
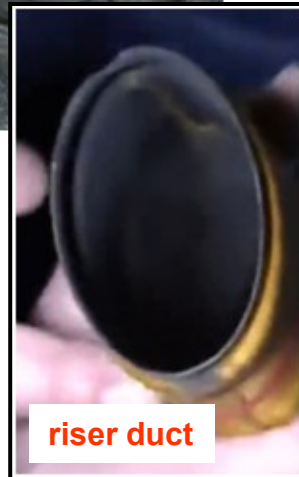
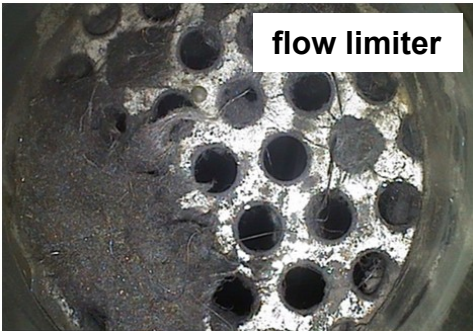

<http://CabinAir.ProfScholz.de>

Air Conditioning System (ATA 21)

Mixing Unit, HEPA Filters, Recirculation Fan



Airbus A320

Air Conditioning System (ATA 21)

HEPA Filter

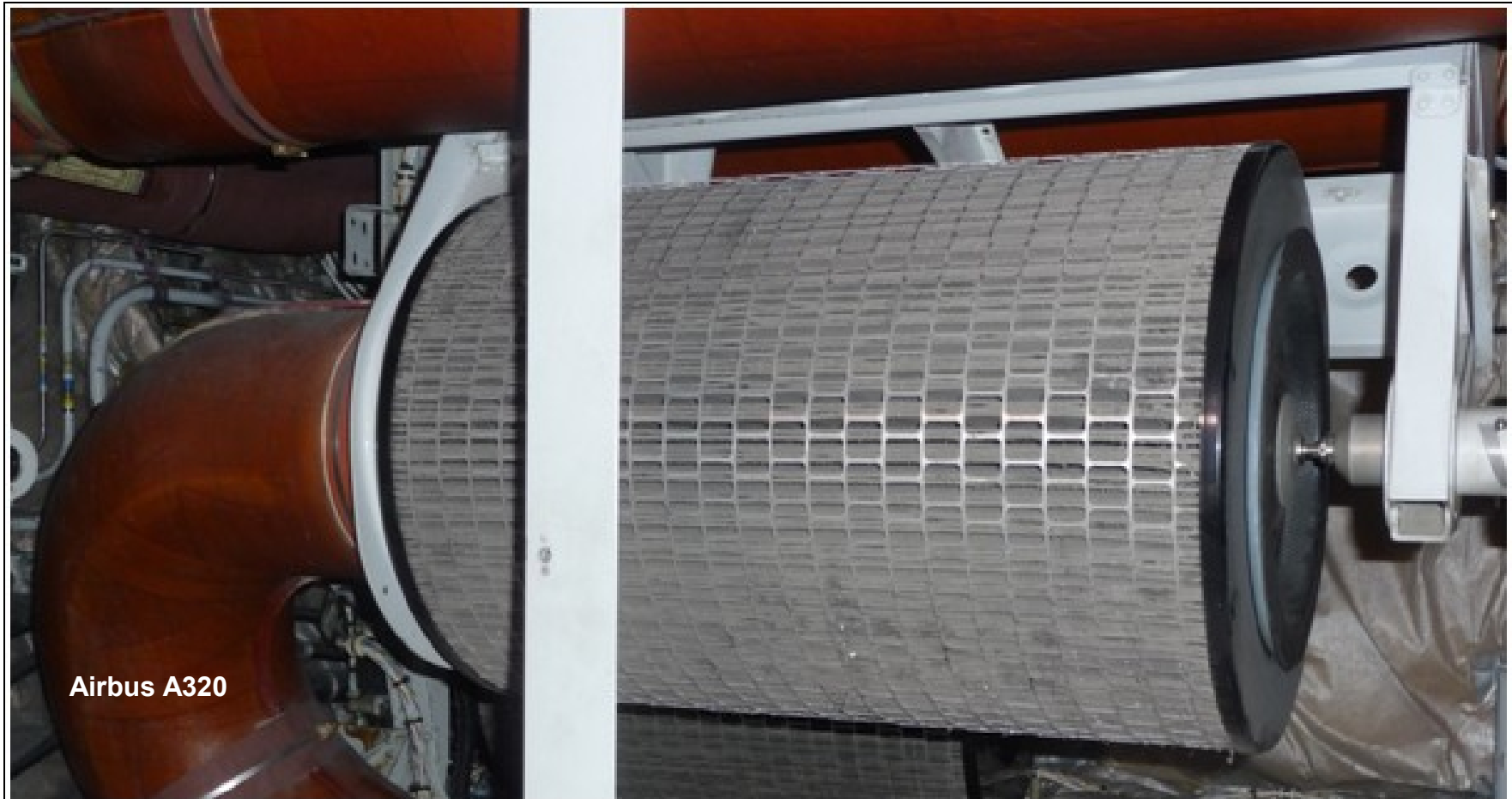

Air Conditioning System (ATA 21)

HEPA Filter



Airbus A380, Emirates

Aircraft Cabin Ventilation in the Corona Pandemic – Legend and Truth

Pneumatic System

Pneumatic System System (ATA 36)

Overview

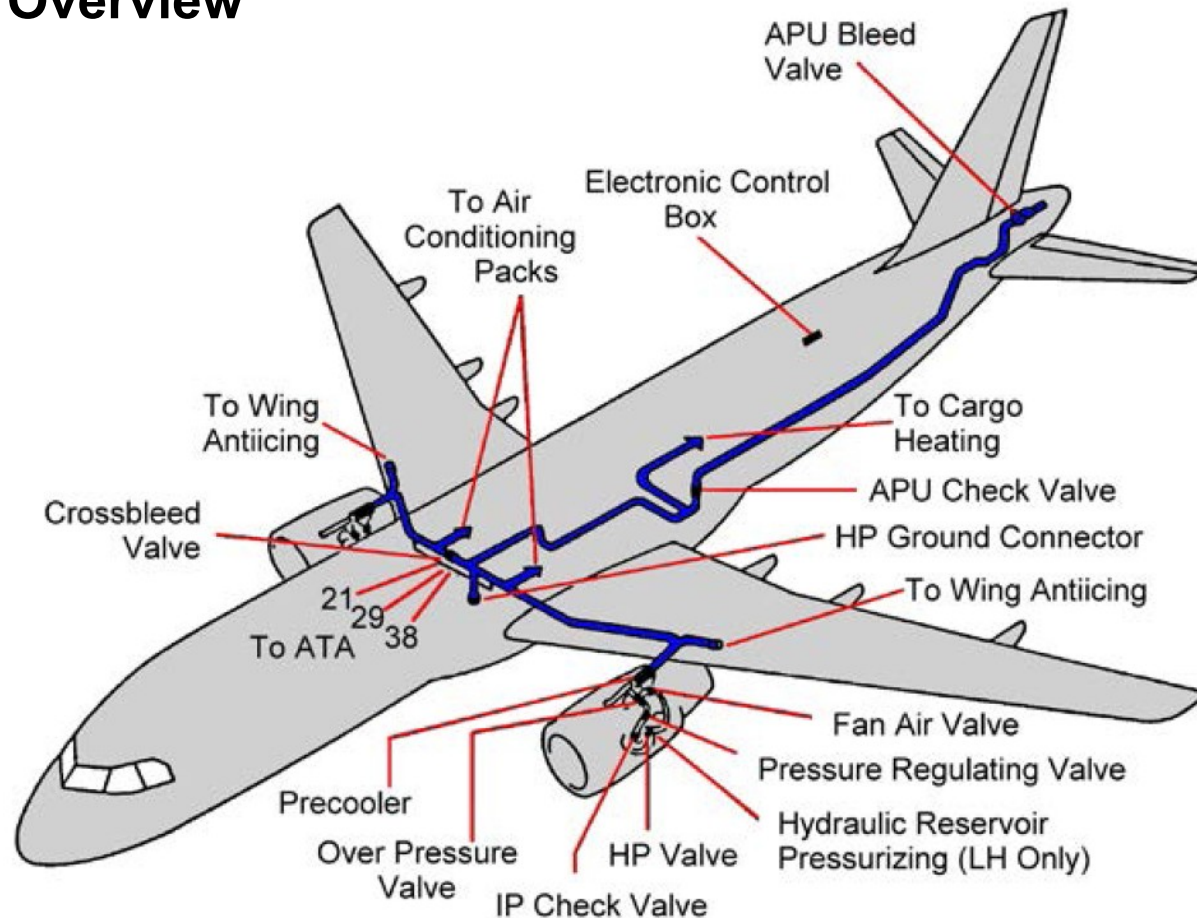

Airbus A320

Pneumatic System System (ATA 36)

Bleed Air – Pressure and Temperature Control

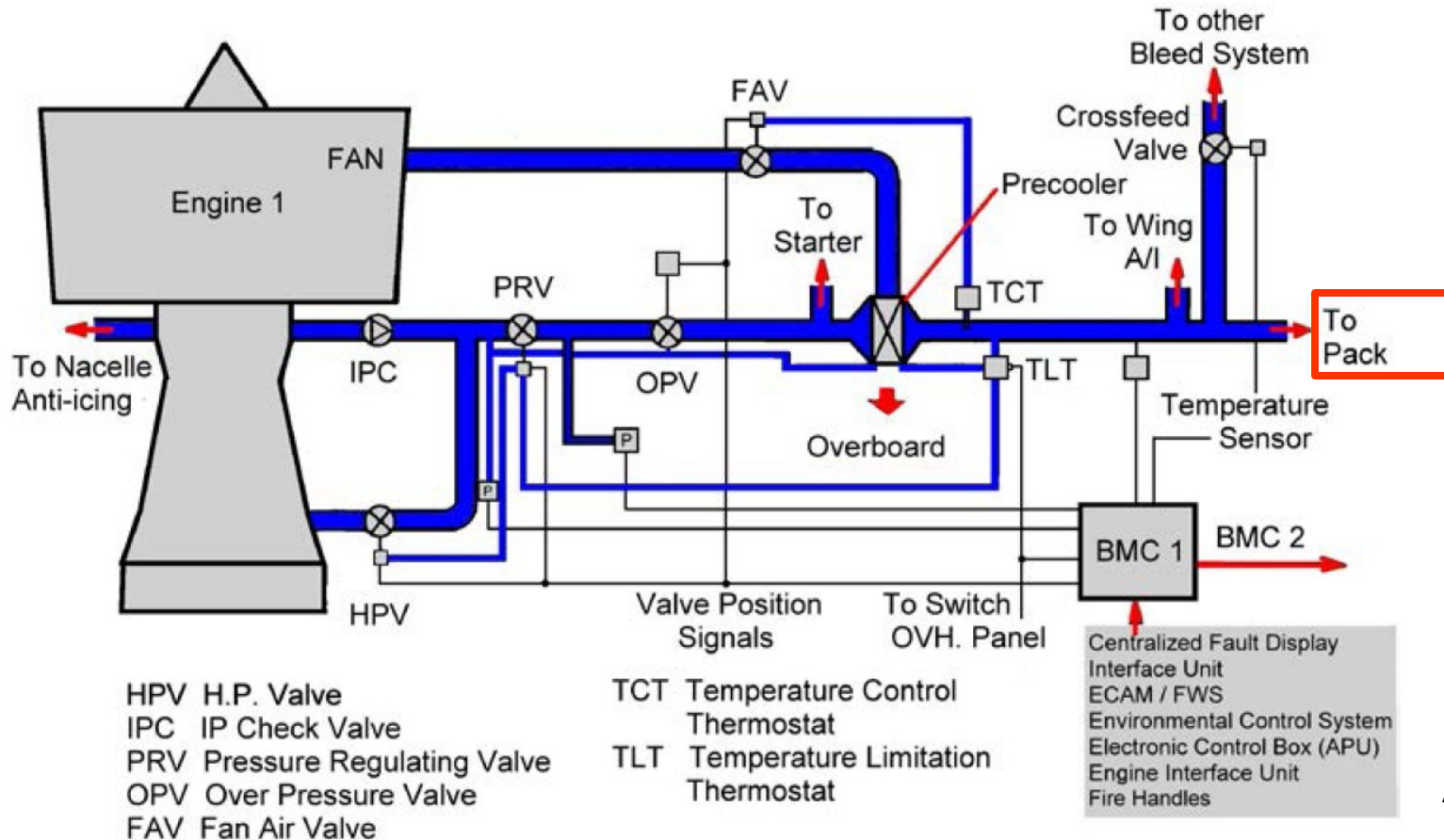

Airbus A320

Pneumatic System System (ATA 36)

High Pressure Valve, Intermediate Pressure Valve

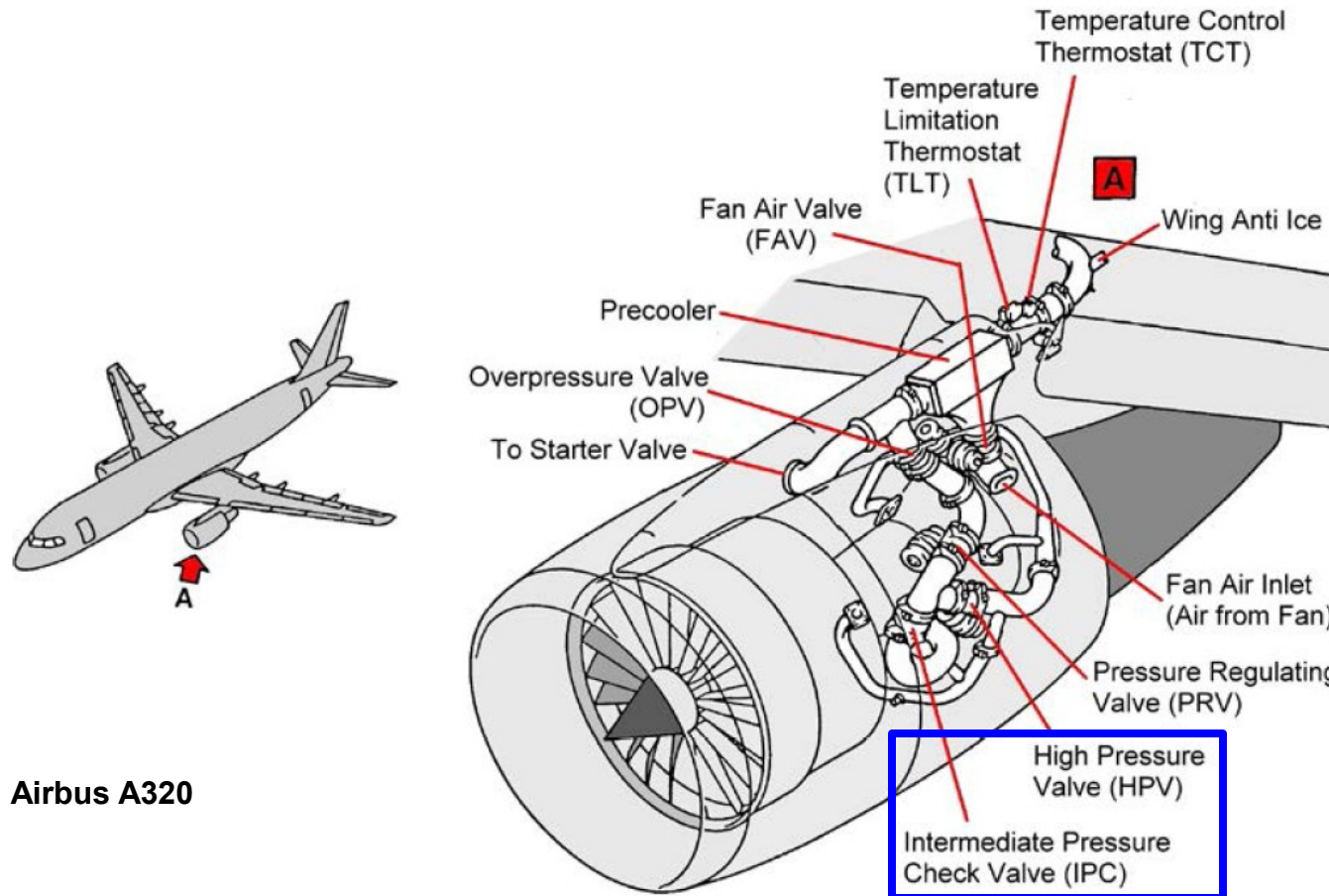

Airbus A320

Turbofan Engine – Bleed Air Extraction

Turbofan Engine – Bleed Air Extraction

Bleed Air Extraction from the Core Flow

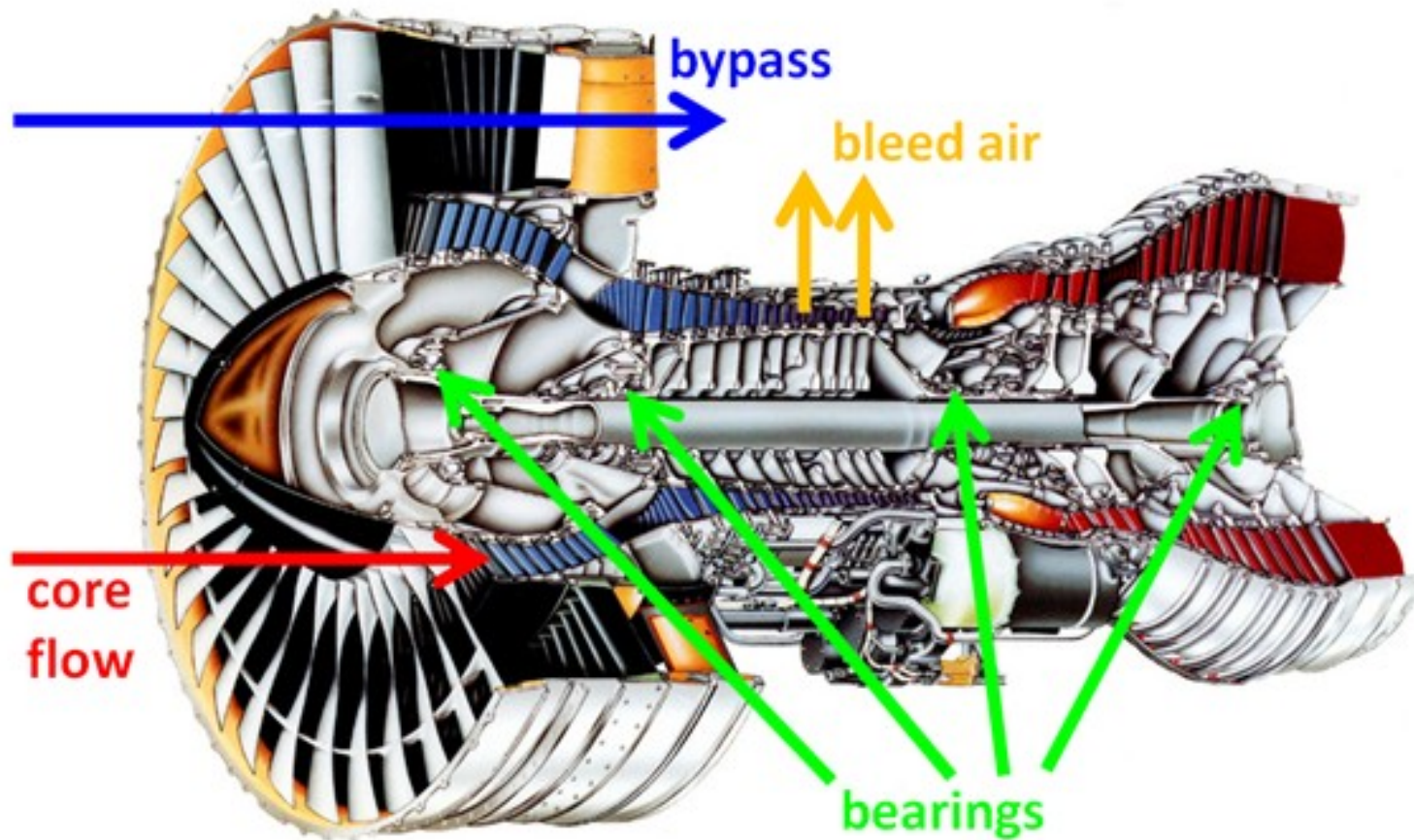

Turbofan engine PW4000-94

Turbofan Engine – Bleed Air Extraction

Bleed Air Extraction from Defined Compressor Stages

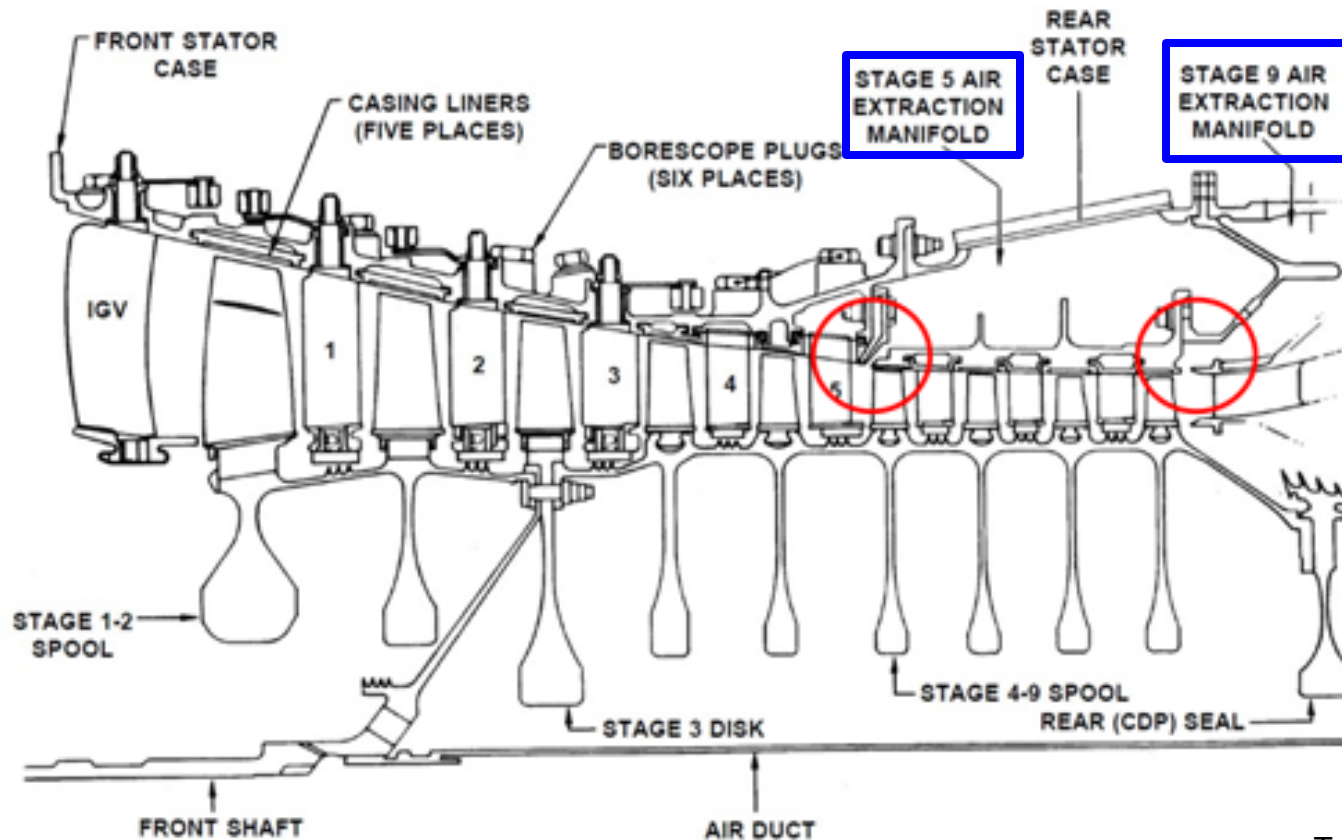

Turbofan engine CFM56

Cabin Ventilation Theory

Cabin Ventilation Theory

Ventilation Equation

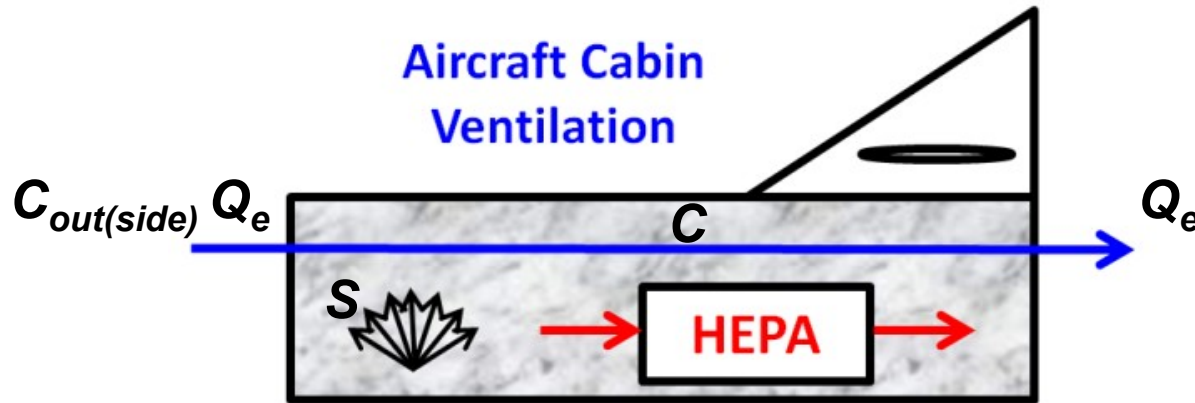

$$S + Q_e C_{out} - Q_e C = V \frac{dC}{dt}$$

- S: source strength in kg/s
- Q_e: effective air flow rate for ventilation in m³/s
- C: concentration of CO₂ or any other substance in kg/m³ in the room
- C_{out}: concentration of CO₂ or any other substance in kg/m³ outside of the room
- V: volume of the room

Dieter Scholz:

Aircraft Cabin Ventilation Theory,
Memo, 2020-06-27.

<https://doi.org/10.31224/osf.io/ac6p8>

See this document for a List of References mentioned in this section.

Cabin Ventilation Theory

Solving the Ventilation Equation for Steady State

If C_{out} is zero, the respective term can be deleted from the equation. The same is true, if C is understood as the difference of the concentration to the outside (ambient) concentration.

$$S - Q_e C = V \frac{dC}{dt}$$

In case of a **steady state** situation (no change in concentration C), the equation simplifies to

$$C = \frac{S}{Q_e}$$

We learn: The **concentration** is independent of the volume V and **depends only on the source strength S and the effective air flow rate Q_e .**

Cabin Ventilation Theory

Air Change Rate and Time for One Air Change

The **air change rate** n (in 1/h) is

$$n = \frac{Q}{V}$$

Q : **air flow rate** for ventilation in m^3/s

The **time for one theoretical air exchange**, t_{n1} is

$$t_{n1} = 1/n \quad .$$

Cabin Ventilation Theory

Types of Ventilation and Ventilation Efficiency, η

Displacement Ventilation

Mixed Ventilation

Short Circuit Ventilation

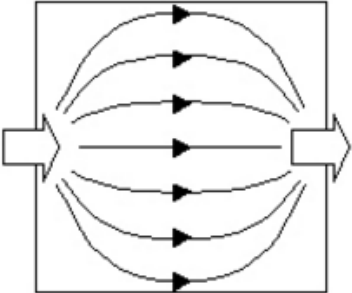
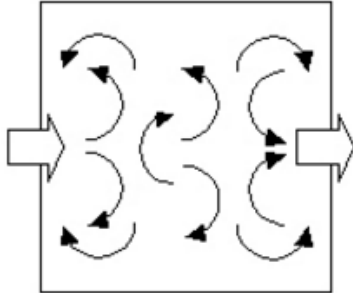
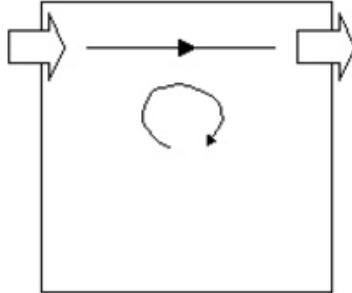
Verdrängungslüftung	Verdünnungslüftung/ Mischlüftung	Kurzschlusslüftung
 <p style="text-align: center;">$\eta > 1$</p>	 <p style="text-align: center;">$\eta = 0.25 \dots 1$</p>	 <p style="text-align: center;">$\eta \rightarrow 0$</p>
<p style="text-align: center;">Lüftungseffizienz > 1</p>	<p style="text-align: center;">Lüftungseffizienz = 1</p>	<p style="text-align: center;">Lüftungseffizienz < 1</p>
<p>Die turbulenzarme Verdrängungslüftung findet beispielsweise bei Quelllüftung oder in Lackierkabinen und Reinräumen Anwendung.</p>	<p>Die turbulente Mischlüftung ist das am häufigsten anzutreffende System (Büro, Versammlungsräume). Die messbare Lüftungseffizienz ist bei bestehenden Lüftungsanlagen jedoch meist deutlich geringer.</p>	<p>Der Luftvolumenstrom wird im Raum kaum als Luftwechsel wirksam.</p>

<https://de.wikipedia.org/wiki/Lüftungseffizienz>

Cabin Ventilation Theory

Effective Air Flow and Ventilation Efficiency, η

The **effective air flow rate** can be determined from the **measured** CO₂ concentration on the aircraft during a steady state situation. With the source strength, S known or artificially introduced

$$Q_e = \frac{S}{C} .$$

The source strength, S is calculated from the people on board the aircraft. Each person has an emission of 0.02 m³/h of CO₂ while resting or with low activity of work – i.e. at a respiration rate of 0.5 m³/h (IDC 2012, 3.14.3). This at standard conditions (1013.25 hPa and 0 °C). The density of CO₂ at these conditions is 1.98 kg/m³. The **ventilation efficiency, η** is subsequently **calculated** from

$$\eta = \frac{Q_e}{Q} = \frac{S}{C n V} \quad \text{or} \quad Q_e = \eta Q = \eta n V .$$

See Appendix A of the Memo for a sample calculation showing the ventilation efficiency in an aircraft based on measuring CO₂ concentrations. **The ventilation efficiency has typically values as low as 25% ... 50%.**

Cabin Ventilation Theory

The Simplified Ventilation Equation for the Unsteady Case

$$S(t) - \eta n V C(t) = V \frac{dC(t)}{dt}$$

This is a first order ordinary differential equation (ODE) with constant coefficients. Laplace transformed:

$$S(s) - \eta n V C(s) = V C(s) s$$

$$\frac{S(s)}{V} - \eta n C(s) = C(s) s$$

$$\frac{S(s)}{V} = C(s) (s + \eta n)$$

$$\frac{C(s)}{S(s)} = \frac{1/V}{s + \eta n} \rightarrow \text{Time Constant (next page)}$$

Cabin Ventilation Theory

The Time Constant, T for Unsteady Ventilation

The **time constant, T** of this PT1-System can be identified as

$$T = \frac{1}{\eta n}$$

We learn: The **speed with which the system reacts** to change is **characterized by the effective air change rate ηn** .

Cabin Ventilation Theory

Solving the Unsteady Ventilation Equation

The transfer function is the pulse response to an initial concentration at $t = 0$ with $C_0 = S/V$.
Transforming back into the time domain

$$\frac{C(t)}{C_0} = e^{-1/T \cdot t} = e^{-\eta n \cdot t} = e^{-\eta \frac{t}{t_{n1}}}$$

With this we can fill the Table below and draw the Figure on the next page.

Table: **Relative remaining concentration** for a ventilation efficiency of $\eta = 1$ versus relative time

$t = x \cdot t_{n1}$	$x = 0.1$	$x = 1/3$	$x = 1/2$	$x = 1$	$x = 2$	$x = 3$	$x = 4$	$x = 5$
$C(t)/C_0$	90.5%	71.7%	60.7%	36.8%	13.5%	5.0%	1.8%	0.67%

T

Cabin Ventilation Theory

Visualizing the Unsteady Ventilation Equation

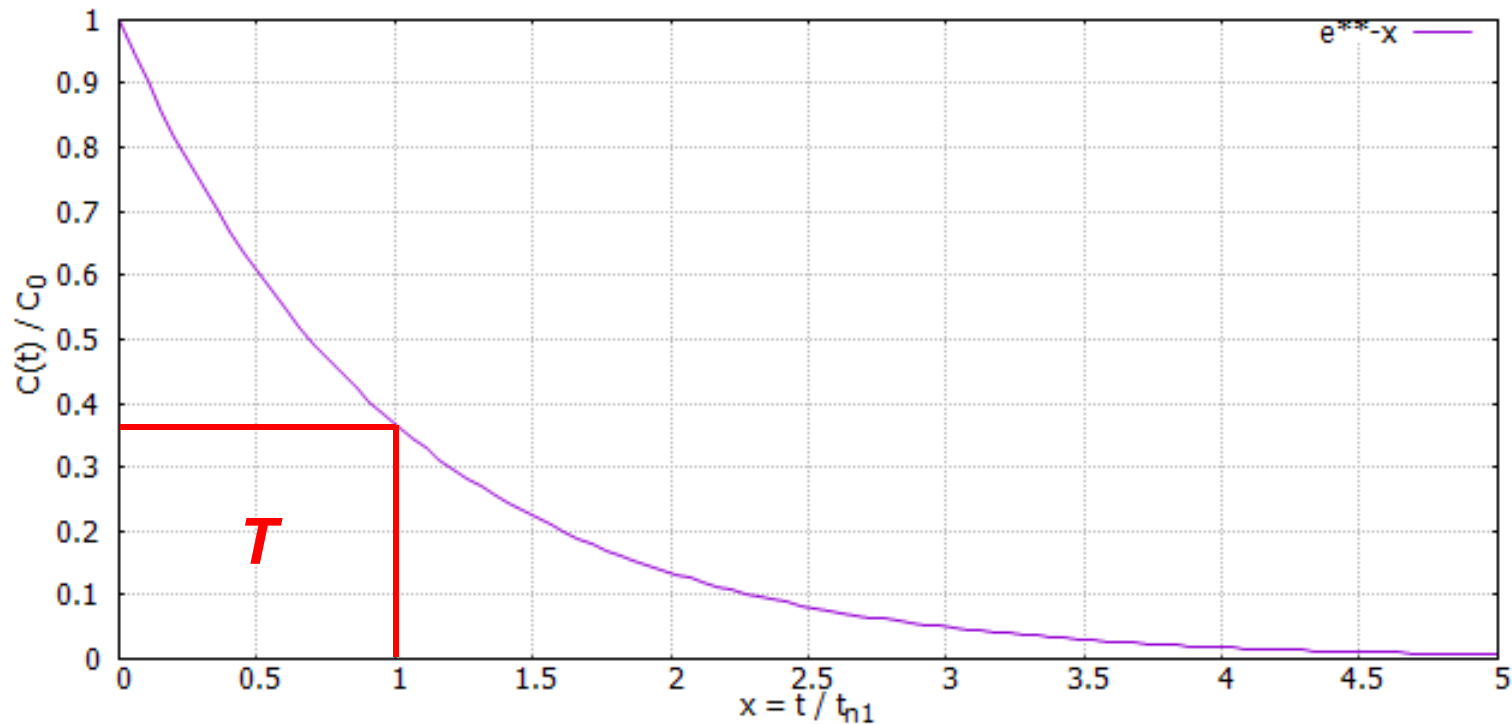

Relative remaining concentration for a ventilation efficiency of $\eta = 1$ versus relative time.

Hence, rinsing is an asymptotic process. A relative concentration will only reach the value 0% of the initial amount after an infinitely long time.

Cabin Ventilation Theory

More from the Unsteady Ventilation Equation

If a certain relative remaining concentration is given (e.g. 12%) and a time (e.g. 4 min.) a **calculation of the time for one (theoretical) air change** can be calculated

$$t_{n1} = -\frac{\eta t}{\ln(C(t)/C_0)} \quad .$$

Assuming a ventilation efficiency of $\eta = 0.75$, we would get the time for one (theoretical) air change as low as 1.4 min. from the above numbers.

Also the **ventilation efficiency could be calculated**, if the parameters in the equation are given as follows

$$\eta = -\frac{t_{n1}}{t} \ln(C(t)/C_0) \quad .$$

Cabin Ventilation Theory

More from the Unsteady Ventilation Equation

ISO 14644-3 (**Cleanrooms** and Associated Controlled Environments - Part 3: Test Methods) defines a "recovery time" (German: Erholzeit). **The recovery time is the time it takes a concentration to be reduced to 1%.**

More details are given in the EudraLex, The Rules Governing Medicinal Products in the European Union, Volume 4, EU Guidelines to Good Manufacturing Practice (EU GGMP 2008). The recovery time is the time a concentration is reduced to 1% (Grade B cleanroom) or 10% (Grade C cleanroom). The EU GGMP include a recommendation that the concentration should decay in 15 min. to 20 min. For interpretation of EU GGMP see Whyte 2016. The decay time can be calculated from

$$t = -\frac{t_{n1}}{\eta} \ln(C(t) / C_0) = -\frac{t_{n1}}{\eta} \ln(0.01) = \underline{4.605} \frac{t_{n1}}{\eta}$$

and can be compared with the EU GGMP-requirement. Reversed, the equation can be used to calculate the required time for one (theoretical) air change t_{n1} .

Cabin Ventilation Theory

Time to "Fully Renew" (1%, ISO 14644-3) the Air in a Room

If $\eta = 46.05\%$ is assumed (Wikipedia 2020)

$$t = 10.0 t_{n1}$$

We learn: **The air in a room will never be "fully renewed", but a remaining concentration of 1% may be accepted to call this "fully renewed"** (in accordance with ISO 14644-3). As a rule of thumb "fully renewed" is achieved during a time about ten times the time for one (theoretical) air change.

If the time for one (theoretical) air change is 3 minutes, the air can be considered to be "fully renewed" in 30 minutes.

Legend or Truth?

Legend or Truth?

Industry Claim 1:

The air in the aircraft **"as clean as in a hospital operating theatre"**
(due to HEPA filters)

- **Wrong logic applied:** Even if the HEPA filters would filter out 100% of the viruses in the SUPPLIED air, the AIR IN THE CABIN is still NOT virus free, because the viruses are in the cabin in the first place.
- **50% reduction to (unknown) reference:** What is possible is this. The virus concentration in the cabin can be halved (with 50% recirculation) if, in addition, recirculation with a 100% effective HEPA filter is used. $C = S / Q$.
- **HEPA filters may not exist or not work:** There are no binding requirements for the existence (some smaller aircraft do not have them) or the maintenance of HEPA filters in aircraft. Therefore, no information can be given about their quality in practice. But: Filtration efficiency may even improve, when filters are old and dirty.

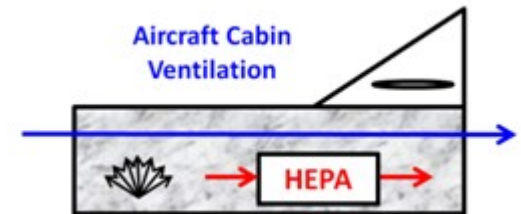

IATA:



<https://perma.cc/686X-X9AZ?type=image>

Legend or Truth?

Industry Claim 1:

The air in the aircraft "as clean as in a hospital operating theatre"
(due to HEPA filters)

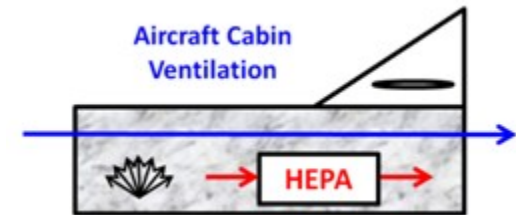
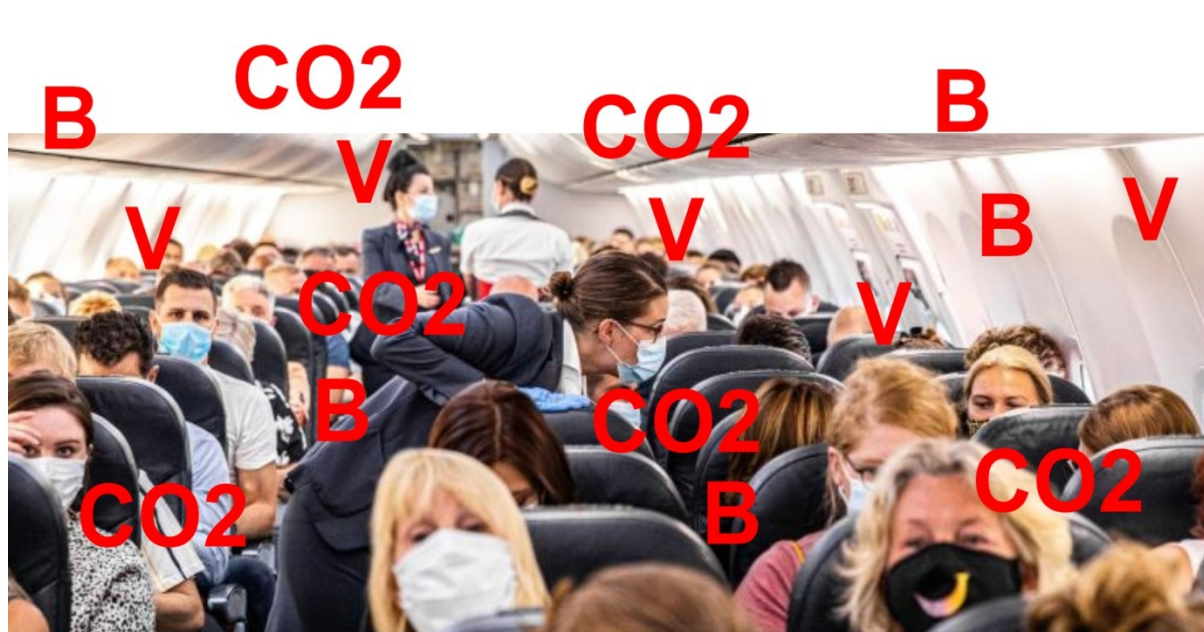

True comparison: The air is as clean as in a hospital operating theatre, if ≈ 200 people are watching.
 o Hospitals filter incoming air – aircraft filter recirculated air.
 o Incoming air is NOT filtered on passenger aircraft. This can lead to cabin air contamination.

Legend or Truth?

Industry Claim 2:

The air in the aircraft is "**FULLY renewed every 2 to 3 minutes**"

- **Statement is irrelevant:** The air change rate is only important for dynamic processes (not relevant here!). $C = S / Q$.
- **Unfit parameter for comparison:** The air change rate, n in the aircraft is only so high because the volume V per passenger (about 2 m^3 on an airplane) is so small. This makes the air change rate, n unfit as a parameter for comparison with rooms where people have more volume each (office, cathedral, ...).
- **One air change in 3 minutes is wrong:** For 0.25 kg of air per minute and person and 2 m^3 per person, a cabin volume of fresh air must flow into the cabin at least every 6.7 minutes. Aircraft better than required? Manufacturers seem to use the "cabin volume" (volume above cabin floor) instead the "volume in the pressure seals" to calculate one theoretical air change in about 3 minutes.
- **Statement "fully" is wrong:** With optimal mixed ventilation (which is never the case in practice), the concentration of a substance is reduced to 37% of the original value after one air change. Only after 5 air changes does the concentration drop below 1% (assuming a ventilation efficiency of $\eta = 1$).

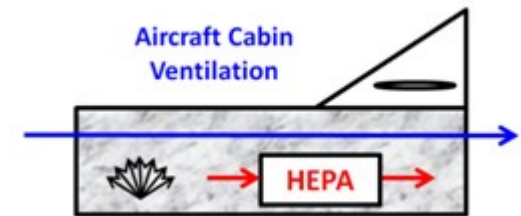

IATA:



<https://perma.cc/686X-X9AZ?type=image>

Legend or Truth?

Industry Claim 2:

The air in the aircraft is " **FULLY renewed every 2 to 3 minutes** "

No, see video: 5 air exchanges are necessary!



Video: <https://youtu.be/QYP255V03BY?t=544>

Legend or Truth?

Industry Claim 2:

The air in the aircraft is " **FULLY renewed every 2 to 3 minutes** "

Ventilation Comparison

Aircraft

versus

Home

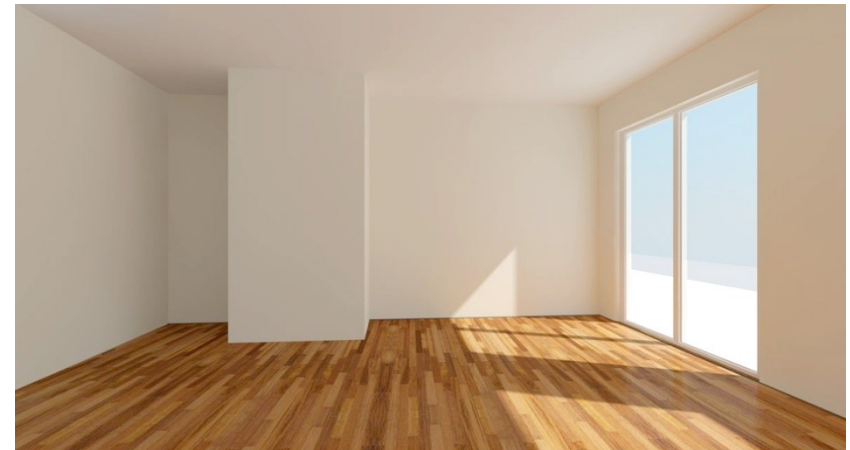

Ventilation rate: $Q = 18 \text{ m}^3/\text{h}$ (0.25 kg/min)
 Volume per person: $V = 2 \text{ m}^3$
 Air change rate: $n = Q / V = 18/2/\text{h} = 9/\text{h}$
 One air change in: $t = 6.7 \text{ min}$

$Q = 90 \text{ m}^3/\text{h}$ relevant value
 $V = 36 \text{ m}^2 \cdot 2.5 \text{ m} = 90 \text{ m}^3$
 $n = Q/V = 90/90/\text{h} = 1/\text{h}$
 $t = 1 \text{ h} = 60 \text{ min}$ irrelevant value

Ventilation rate in the (my) home is 5-times that of the aircraft!

Video: <https://youtu.be/QYP255V03BY?t=375>

Legend or Truth?

Industry Claim 3:

The **air flow** in the aircraft cabin "**only from top to bottom**" or "**no horizontal flow**" (not sideways, not forward or aft)

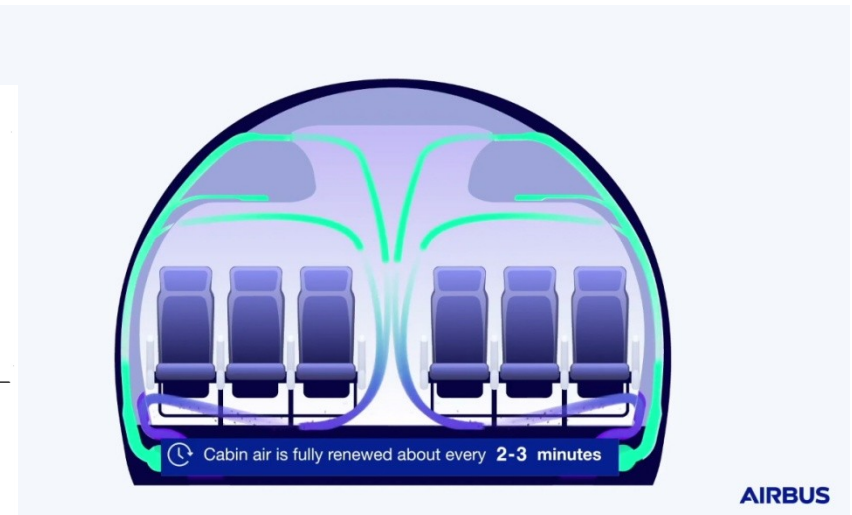
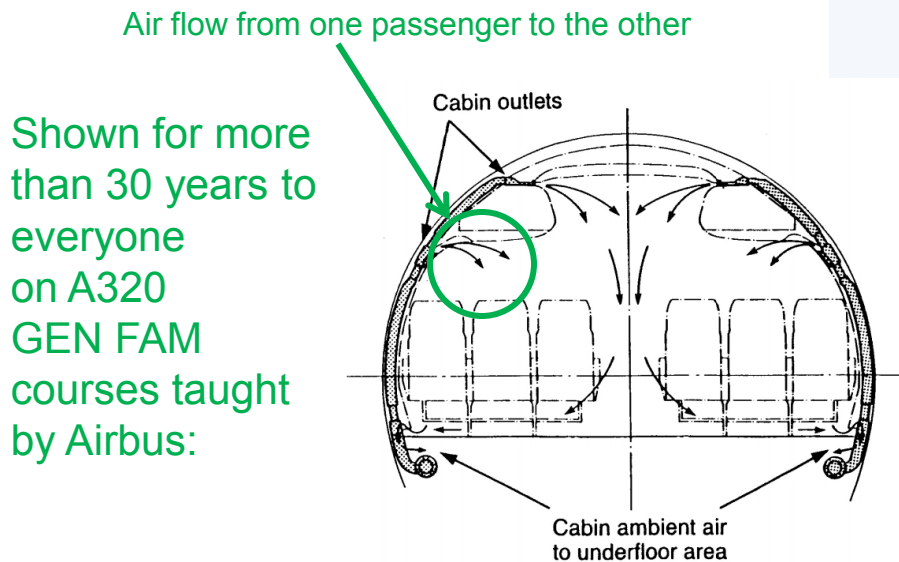

Airbus: Video: https://youtu.be/tVkf2ogGG_Y?t=45

Air flow only overhead the passengers?

- In the cross-section of the cabin, the ventilation causes **vortices**, which **mix the air within several rows of seats**.
- **Turbulence and diffusion also mix the air along the cabin** (forwards and backwards).

Legend or Truth?

Industry Claim 3:

The **air flow** in the aircraft cabin "**only from top to bottom**" or "**no horizontal flow**" (not sideways, not forward or aft)

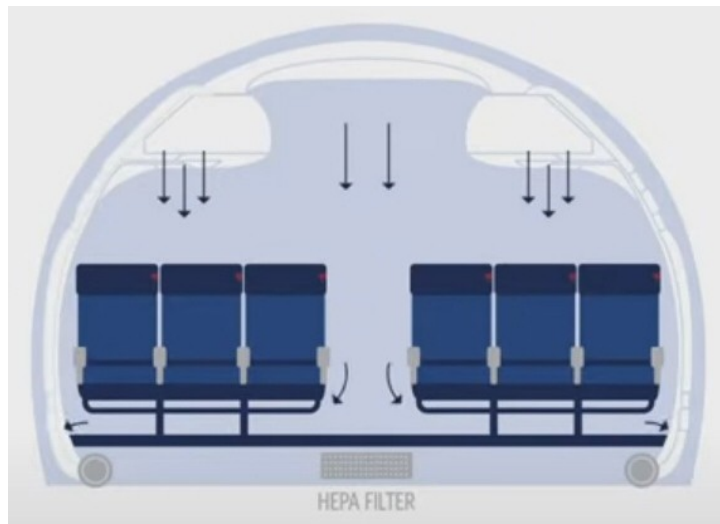

Delta: Video: https://youtu.be/ll-4LUfcr_s?t=33

Air flow only from top to bottom?
Cabin air ventilation out of the overhead bins?



Delta: Video: https://youtu.be/ll-4LUfcr_s?t=67



Legend or Truth?

Industry Claim 3:

The **air flow** in the aircraft cabin "**only from top to bottom**" or "**no horizontal flow**" (not sideways, not forward or aft)

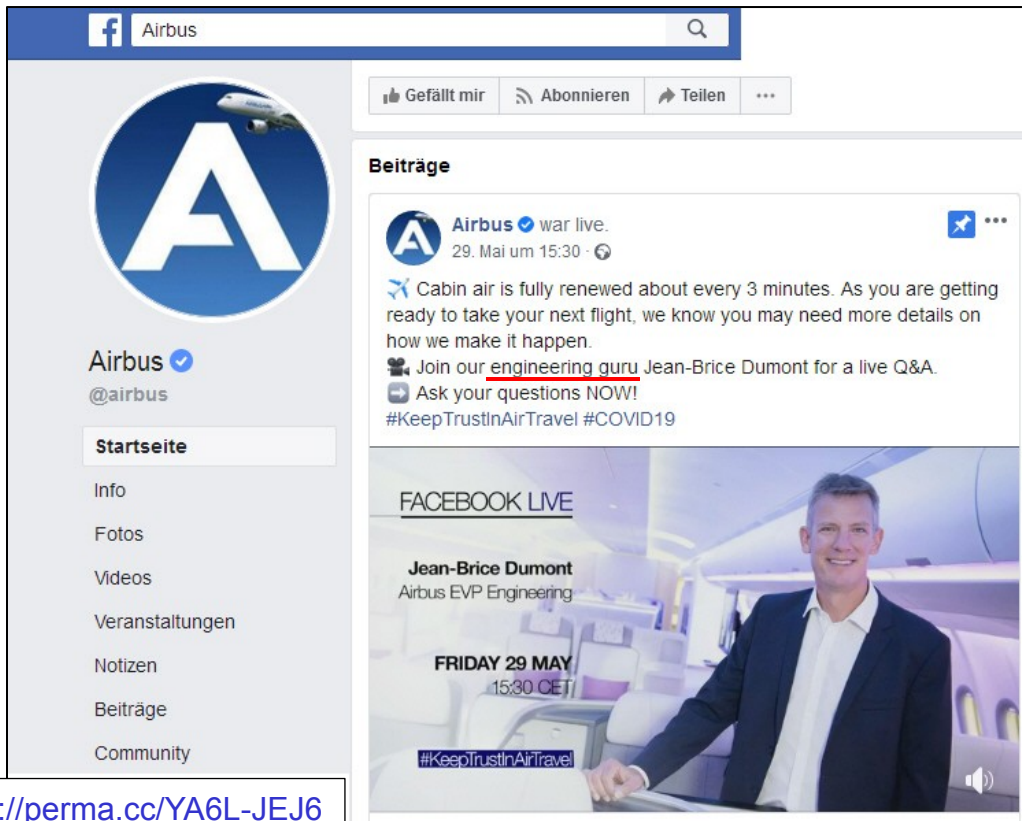

<https://perma.cc/YA6L-JEJ6>

Jean-Brice Dumont, Airbus ("guru"):
It [the air] flows from top to bottom at one meter per second, and is subsequently removed through the floor. This airflow is optimized to prevent longitudinal movement, so there is no spread between adjacent seat rows.

Facebook, 29.05.2020

Dieter Scholz:
Airbus' Cabin Air Explanations during the Corona Pandemic – Presented, Analyzed, and Criticized, Memo, 2020-06-19.
<https://doi.org/10.31224/osf.io/b9dkp>

<https://www.facebook.com/watch/?v=582384906021127>
 Video: <https://youtu.be/LV00dLUdK0k>

Legend or Truth?

Industry Claim 3:

The **air flow** in the aircraft cabin "**only from top to bottom**"

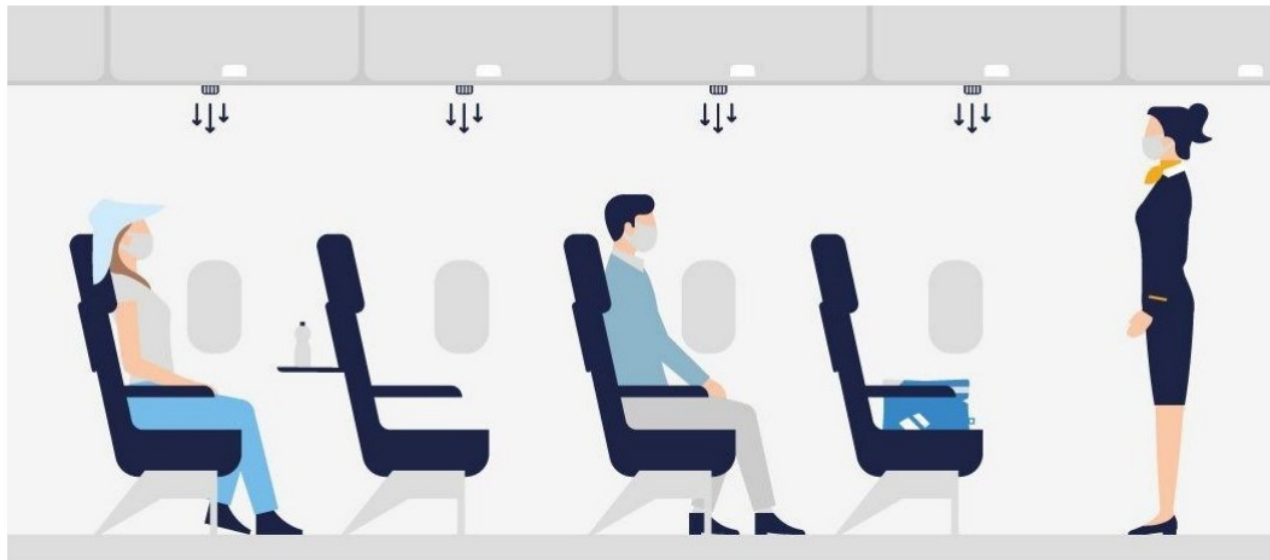

Lufthansa under the heading "#WeCare – damit Sie unbesorgt fliegen"

(<https://perma.cc/UQ59-AZ3F>).

Air flows from the air jets. This is in contrast to the EASA recommendations.

(<https://perma.cc/MR7X-Y73R>). Turbulence should be avoided in the cabin.

Turbulence is also caused by walking through the aisle.

Legend or Truth?

Industry Claim 3:

The **air flow** in the aircraft cabin "**only from top to bottom**"

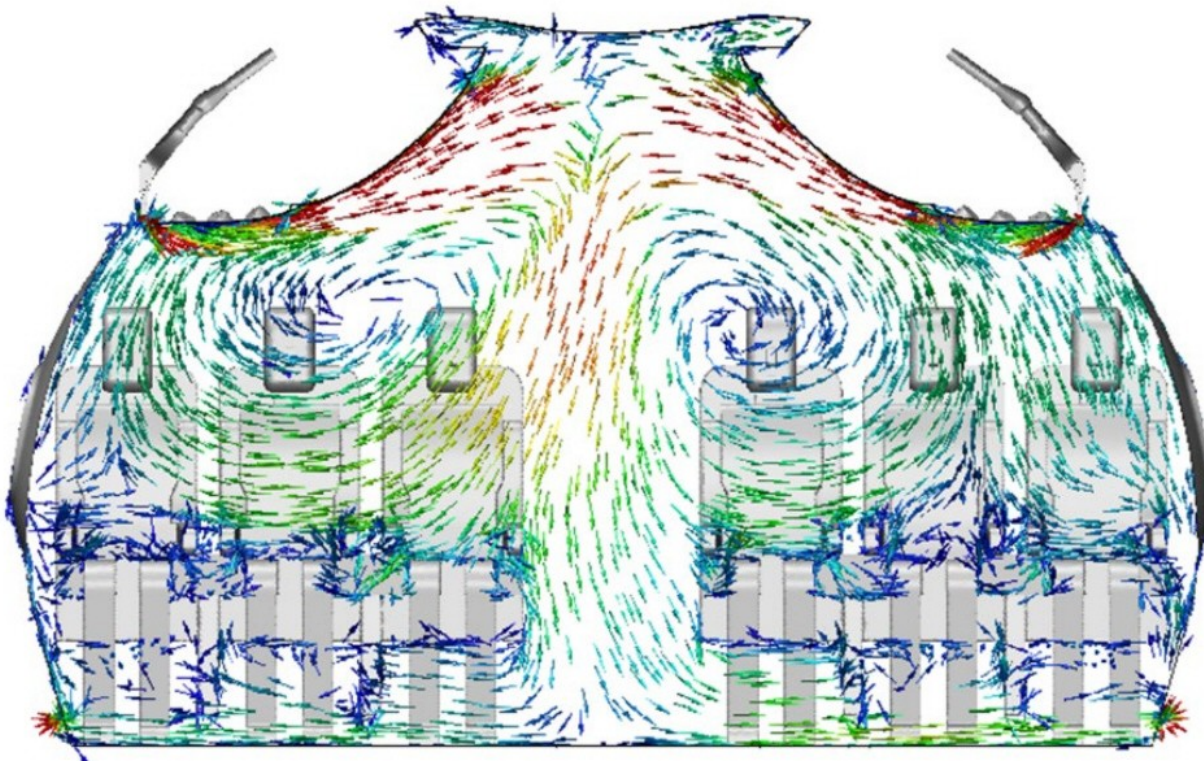

Flow direction indicated by the arrows show **flow from one passenger to the other** and as such the exchange of breathing air.

Nevertheless,

Boeing concludes:

"**the risk of contracting COVID-19 while flying is low.**"

Engineering controls on modern aircraft that employ high air flow from ceiling to floor, HEPA filtration, and set design / positioning that minimize air flow between rows, and play an important role in the control of particle fate in the cabin."

Source:

<https://perma.cc/S5VV-UNS2>

Boeing: CFD simulation of flow in a **B737** cabin cross section. Snapshot of a dynamic situation.

Legend or Truth?

Industry Claim 3:

The **air flow** in the aircraft cabin "**only from top to bottom**"

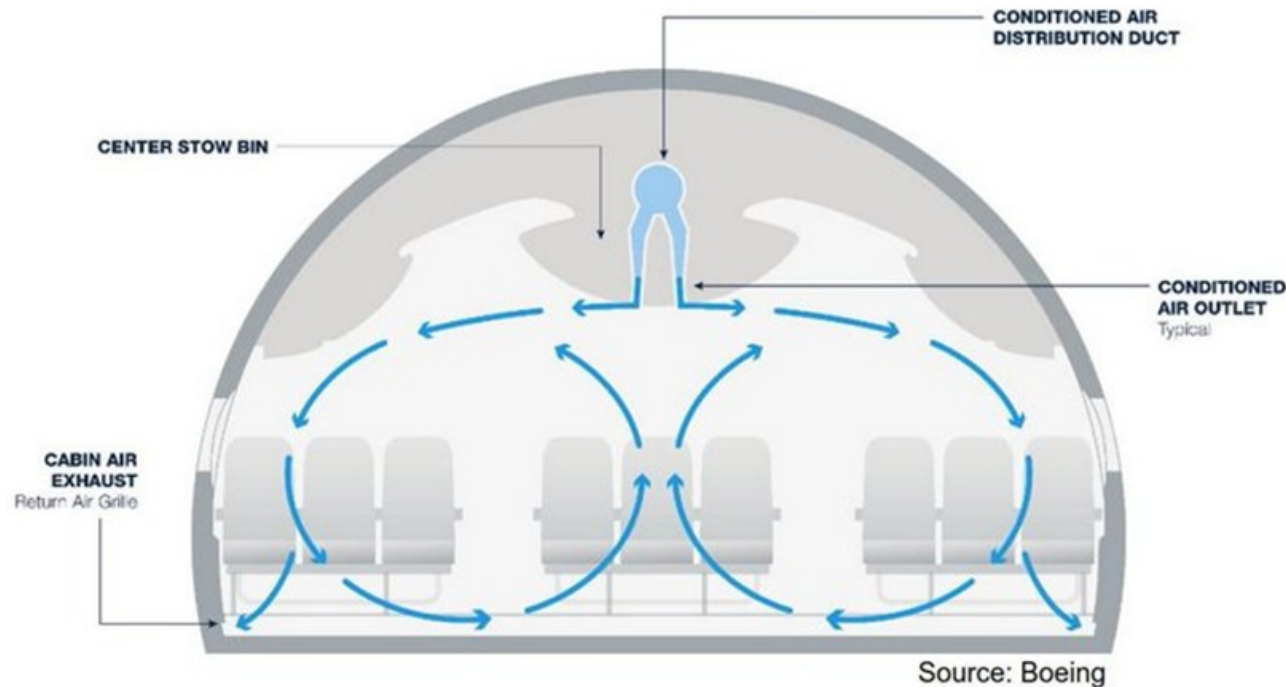

Boeing shows its special (unfavorable) case of the [B767](#) with central ventilation from the top initially sideways (to avoid drafts on passengers in the center bench). Visible are the rotors typical for every cabin ventilation to ensure full rinsing and mixing.

Legend or Truth?

Industry Claim 3:

The **air flow** in the aircraft cabin "**only from top to bottom**"

Explanations Given by Science:

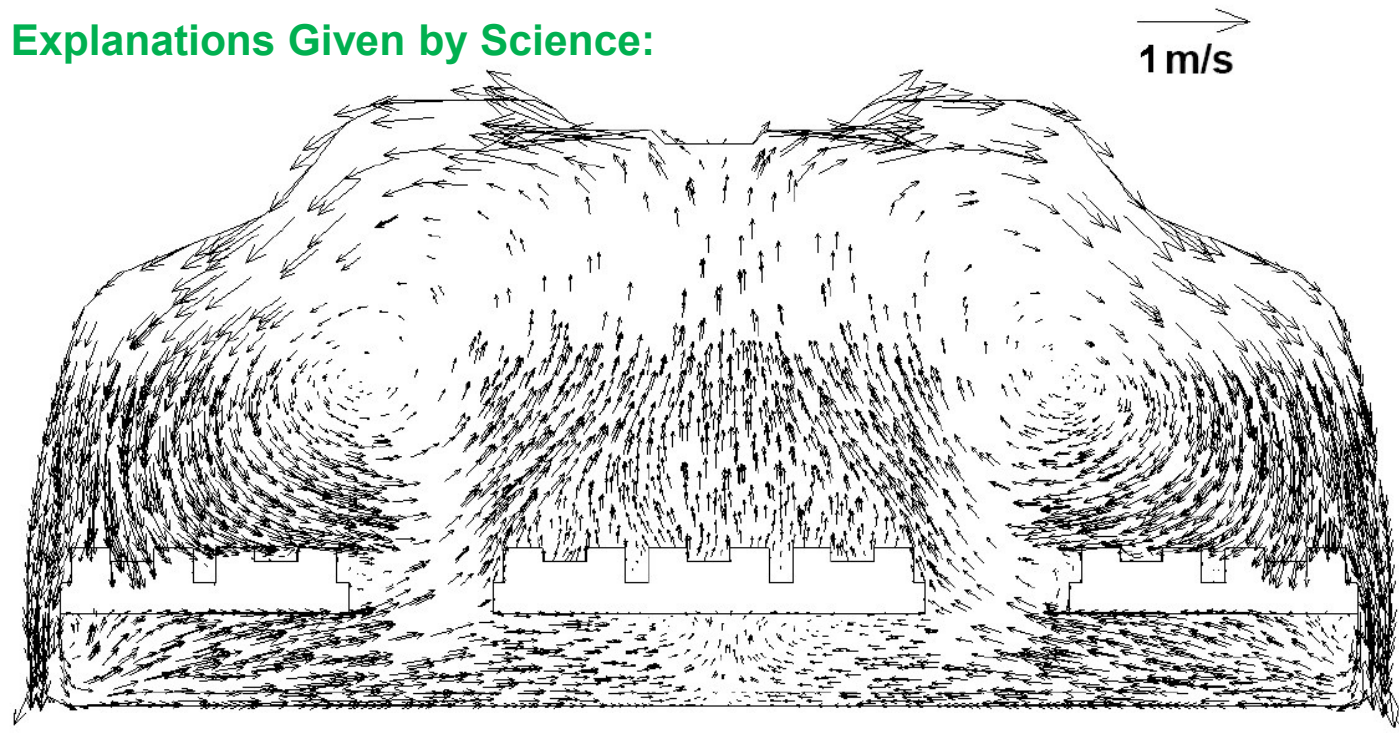

The special (unfavorable) case of the **B767** was studied by **Prof. Chen, Purdue University**.

Gupta, J., Lin, C.-H., and Chen, Q, 2011. Transport of Expiratory Droplets in an Aircraft Cabin. In: *Indoor Air*, 21(1), 3-11. Archived at: <https://perma.cc/QD3Z-YTVA>

Legend or Truth?

Industry Claim 3:

The **air flow** in the aircraft cabin "**only from top to bottom**"

Explanations Given by Science:

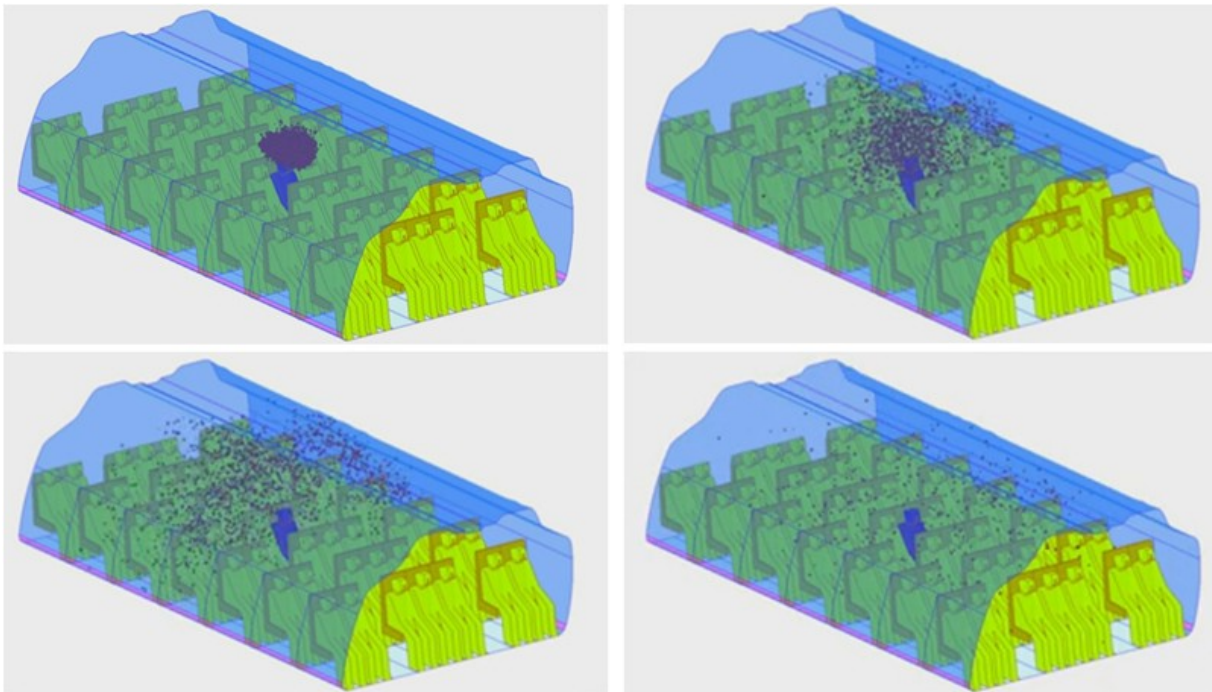

The special (unfavorable) case of the B767 was studied by Prof. Chen, Purdue University.

Video: <https://engineering.purdue.edu/~yanchen/infection.html>

Legend or Truth?

Industry Claim 3:

The **air flow** in the aircraft cabin "**only from top to bottom**"

Explanations Given by Science:

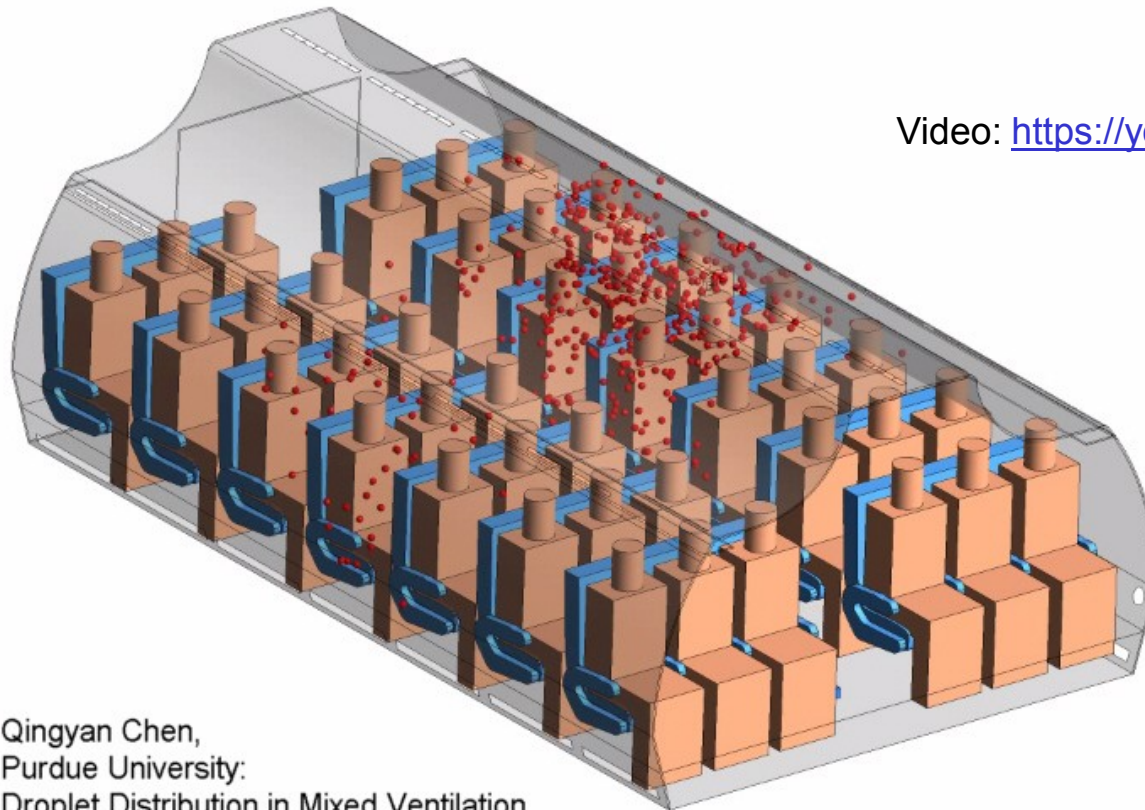

Video: https://youtu.be/t2QV5aqo_bl

Qingyan Chen,
Purdue University:
Droplet Distribution in Mixed Ventilation

Legend or Truth?

Industry Claim 3:

The **air flow** in the aircraft cabin "**only from top to bottom**"

Explanations Given by Science:

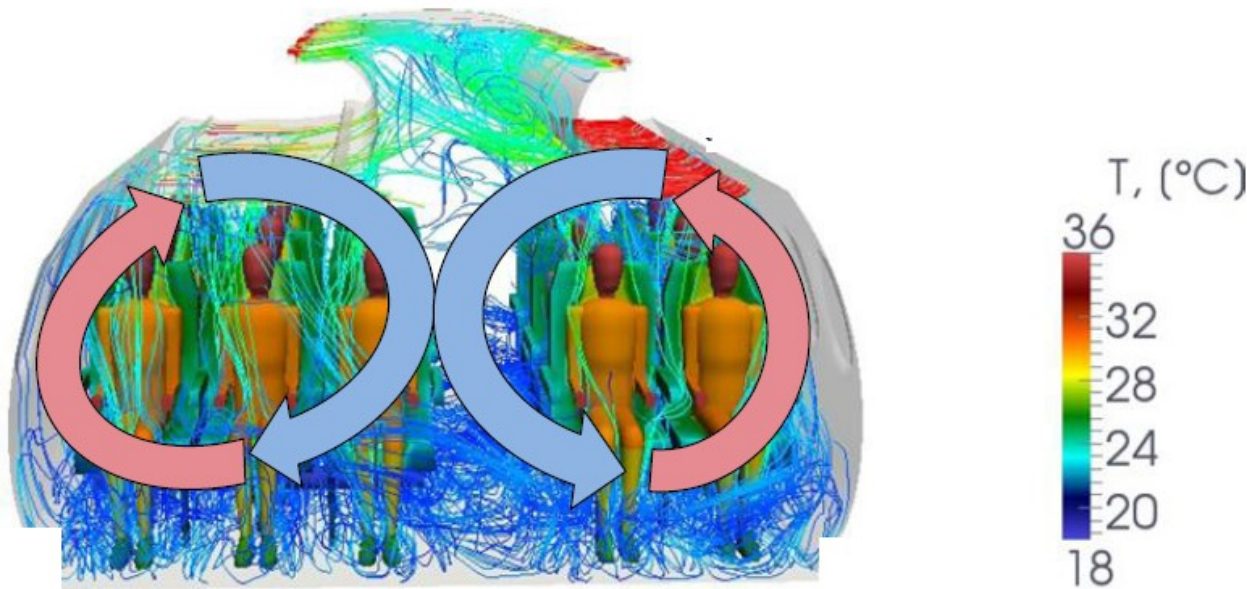

The aircraft cross section is ventilated with "rotors" on either side of the aisle.
The cabin is cooled with cold air from above. Warm air rises up near the windows.

By courtesy of DLR.

Legend or Truth?

Industry Claim 3:

The **air flow** in the aircraft cabin "**only from top to bottom**"

Explanations Given by Science:

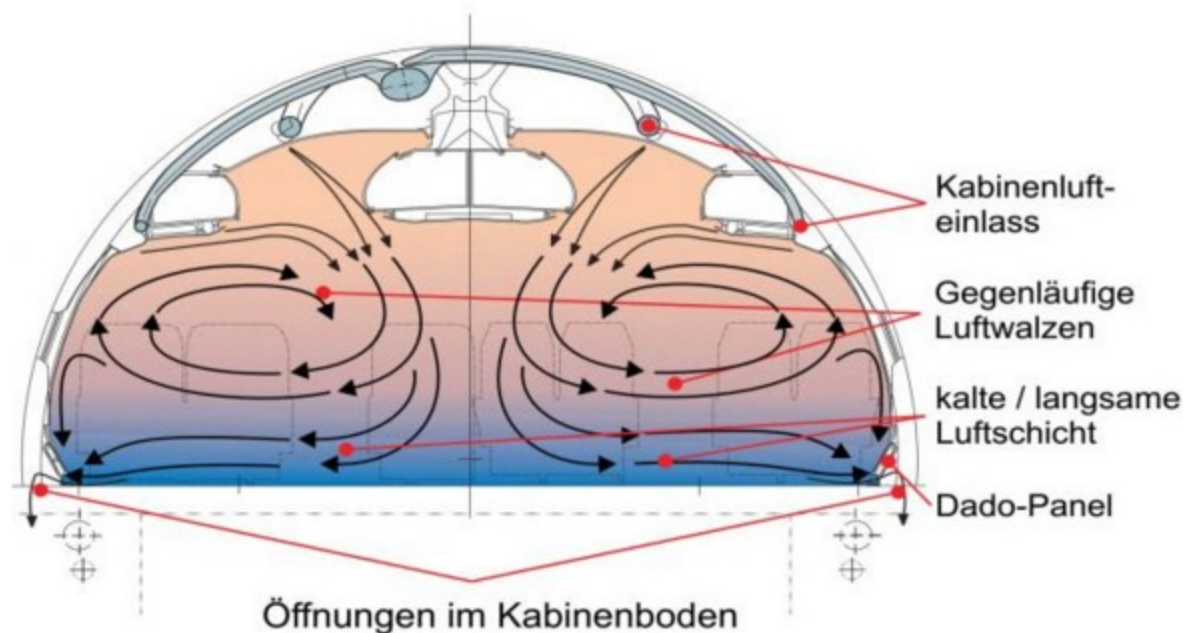

Flow in the cabin of an Airbus A340. Here, the cabin temperature is increased with warm air from the outlets. Rotors are present on either side of the center line. **The flow** (see arrows) transports breathing air from one passenger to the other.

KNIGGE, Henning, 2014: *Modellierung des dynamischen Verhaltens der zonalen Kabinentemperatur und anderer Komfortparameter in Flugzeugkabinen*. Dissertation, Technische Universität Hamburg-Harburg. Göttingen: Cuvillier.

Legend or Truth?

Industry Claims 4 and 5

- **Claim 4:** The **seats provide a barrier** for transmission to the front and rear of the cabin. **Refuted:** Simulations show droplets pass seat rows easily.
- **Claim 5:** The **passengers look forward** and **have little facial contact**.



Dieter Scholz:
Airbus' Cabin Air Explanations during the Corona Pandemic – Presented, Analyzed, and Criticized, Memo, 2020-06-19.
<https://doi.org/10.31224/osf.io/b9dkp>

Jean-Brice Dumont, **Airbus**, explains on Facebook that all viruses will move forward, even when looking to your neighbor – as in this picture. Video: <https://youtu.be/LV00dLUdK0k>

Legend or Truth?

Industry Claim 6:

6 feet physical distancing minimum without a mask (CDC recommendation) **is equivalent to 1 foot distance onboard the aircraft** with a mask.

Scientific facts:

- **No airflow** that separates passengers.
- **No masks** are worn during extended periods (meals) during flight (especially in first class).

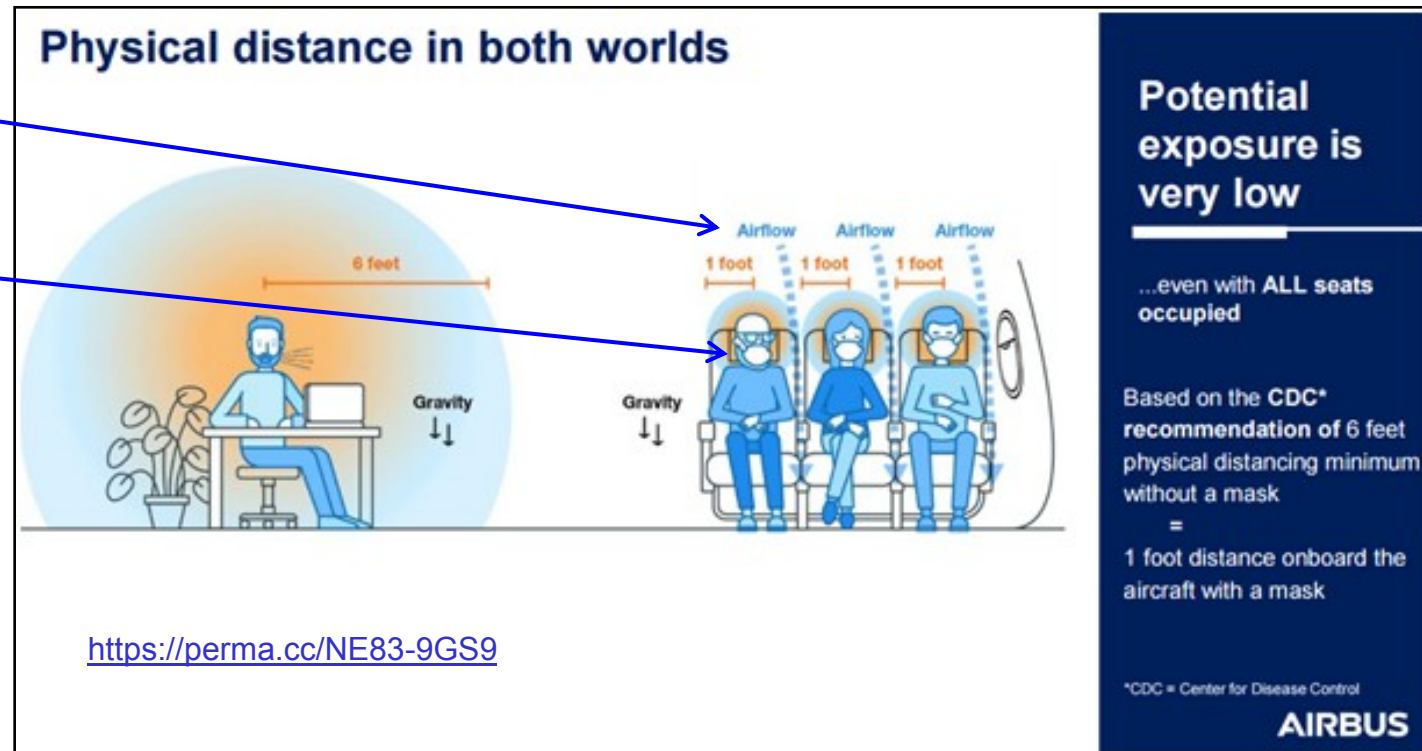



Legend or Truth?

Industry Claim 7:

"But with just 44 published cases of potential inflight COVID-19 transmission among 1.2 billion travelers, the risk of **contracting the virus on board appears to be in the same category as being struck by lightning**," said **Alexandre de Juniac**, IATA's Director General and CEO up to 2020. (<https://perma.cc/S29W-VDNM>)

However, 44 cases is just based on 13 studies (IATA: <https://perma.cc/Y2VV-ZJEM>), but this number divided by all passengers in 2020 is ... **'Bad math'** says Dr. David Freedman, a U.S. infectious diseases specialist.



 **REUTERS**

MON OCT 19, 2020 / 9:21 AM EDT

'Bad math': Airlines' COVID safety analysis challenged by expert

Laurence Frost

<https://perma.cc/8SWH-2BKD>

Clean bill of health 99.9%

Efficiency of HEPA filters used by environmental control systems of airliners in removing viruses from cabin air

With Covid-19 the spread is mainly caused by breathing in air when close to an infected person who is exhaling small droplets that contain the virus. By design, modern airliners have the upper hand here, as they are equipped with environmental control systems (ECS) that exchange the entire volume of cabin air for clean outside air every two to three minutes.

The ECS also contains High Efficiency Particulate Air (HEPA) filters – which the makers say provide hospital-grade 99.9% filtration efficiency, and effectively remove viruses like Covid-19. Airbus has fitted such filters to all its aircraft manufactured since 1994.

The number of reports of on board transmission is low, based on the number of published cases globally, Powell says. “The risk has proved, as we thought, to be low compared to other indoor spaces. You would expect that with controlled airflow, highly efficient filtration, mask wearing and everyone facing the same way [in their seats],” he says. “This is actually the less difficult of the two main problems to solve.”

A much harder problem is the issue of importation,

Legend or Truth?

IATA Does Not Give Up on the Topic

Flight International

September 2021



<https://perma.cc/64N4-JVEE>



Dr David Powell advises IATA and its members on Covid-19 measures

Truth Decay?

Truth Decay?

Right or Wrong Does Not Matter Anymore

Definitions from the book:

Disinformation

False or misleading information spread intentionally, usually to achieve some political or economic objective, influence public attitudes, or hide the truth. This is a synonym for propaganda.

"Fake news"

Newspaper articles, televisions news shows, or other information disseminated through broadcast or social media that are intentionally based on falsehoods or that intentionally use misleading framing to offer a distorted narrative

Social Media!

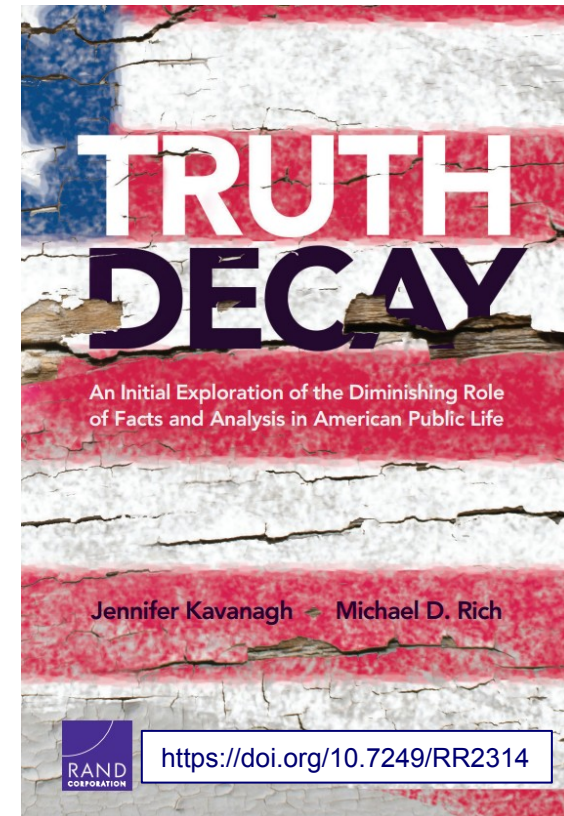

For more related information see:

SCHOLZ, Dieter, 2020. *Aviation Ethics – Growth, Gain, Greed, and Guilt*. German Aerospace Congress 2020 (DLRK 2020), Online, 01.-03.09.2020. Available from: <https://doi.org/10.5281/zenodo.4068009>

Truth Decay?

IATA Active on Facebook

Facebook

21 September 2020

<https://perma.cc/686X-X9AZ?type=image>

International Air Transport Association (IATA) ✓
Yesterday at 9:48 AM · 🌐

Air in an airplane ✈️ is cleaner than people think 🌿.
Here are 4 key reasons why 🙌
#FlySafe #ReadyToFly

HEPA filters in aircraft remove **99.9%** of viruses like COVID-19
Source: Pöhl Aerospace

Cabin air is as clean as a **hospital operating theatre**

Cabin air is **fully renewed** every 2-3 minutes
Hospitals ≈ 10 minutes
Offices ≈ 20 minutes

Cabin air quality is a **50/50 mix** of fresh air and recirculated HEPA filtered air.
Air is fully renewed 20-30 times per hour.

706 42 Comments 1.3K Shares

Truth Decay?

Scientific Services, German Bundestag: Fake-News – Legal Position

Wissenschaftliche Dienste, Deutscher Bundestag: "Fake-News, Definition und Rechtslage", 17.02.2017. - Aktenzeichen: WD 10 - 3000 - 003/17. – URL: <https://perma.cc/GQB2-MM2E>. Quotes from the translated document:

Translated, the term "fake news" means nothing more than "false news". There is currently no generally applicable or even legal definition of the term fake news ... [it] designates ... deliberately false news that was produced specifically for the purpose of viral distribution via the Internet and social networks.

Commercial interests can also be a motive for fake news.

Assertions of fact refer to circumstances in reality that can be proven or refuted. So you can be right or wrong. For a false assertion to be punishable, it depends on whether a person is the subject of the assertion [which is not the case here].

According to a narrower view, the correctness of the information should have significance ... since untrue statements are not worthy of legal protection ... According to this view, fake news as targeted false news are not covered by the protection of freedom of expression.

The publication of general false news without reference to a specific person or group of people ("The euro rate crashed tonight") is generally not a criminal offense. It remains to be said that the existing legal means cannot be used against fake news, which use fictitious stories to raise the mood and do not affect specific people.

The best way to stop people from consuming fake news is through authentic and truthful coverage.

Truth Decay?

Legal and Philosophical Considerations

Legal Considerations (German Law)

A disinformation by the airline becomes problematic, if it causes a declaration of intent in the form of the purchase of a flight ticket. The **passenger deceived about the risk of infection** with COVID-19 could withdraw from the contract due to fraudulent deception with reference to [BGB § 123 \(1\)](#). A passenger who has been infected with SARS-CoV-2 on the plane could, with reference to [BGB § 823 \(1\)](#), demand compensation from the airline for **negligent damage to health**.

Philosophical Considerations

Industry applies lies out of economic interest, which are to be rejected for philosophical reasons. The interpretation of the lies as "white lies" (German: Notlüge) does not apply here ([according to Kant](#)) because there would have to be a "danger to life and limb" (German: Leib und Leben), which is not the case for shareholders, managers or employees. According to Kant there is no right to "white lies" anyway.

According to Carroll, A. B.: The Pyramid of Corporate Social Responsibility. In: Business Horizons, 1991, July/Aug, pp. 39–48. – URL: <https://doi.org/10.1186/s40991-016-0004-6>, it must be observed on level 3 of the pyramid (see next page): "**Ethical responsibilities: Obligation to do what is right, just, and fair. Avoid harm.**"

As such, **it is not compatible with corporate social responsibility ...**

- o **to lie** – not even if it achieves economic advantages at level 1 of the pyramid.
- o **not to mention the dangers posed by COVID-19 in the aircraft**, as this could potentially endanger passengers.

Truth Decay?

Legal and Philosophical Considerations



Carroll's pyramid of Corporate Social Responsibility (CSR)

<https://doi.org/10.1186/s40991-016-0004-6>

Summary

Aircraft Cabin Ventilation in the Corona Pandemic – Legend and Truth

Summary

- In the pandemic, aviation poses two dangers: 1.) The rapid, global spread of the virus and 2.) the mutual contamination of the densely packed passengers in the aircraft cabin, whose ventilation system cannot rule out infection.
- Since Corona, the ventilation technology of aircraft cabins has become a political issue.
- For financial reasons, flying is considered safe by the aviation industry even in Corona times.
- Reason is the aircraft cabin ventilation – better than anything else.
- The ventilation in passenger aircraft is explained incorrectly.
- Here, the ventilation technology is explained: Requirements, basics, related aircraft systems, and ventilation theory.
- Right or wrong does matter!
- We need to adhere to moral principles.

Aircraft Cabin Ventilation in the Corona Pandemic – Legend and Truth

Contact

info@ProfScholz.de

<http://www.ProfScholz.de>

<http://corona.ProfScholz.de>

Quote this document:

SCHOLZ, Dieter, 2020. *Aircraft Cabin Ventilation in the Corona Pandemic – Legend and Truth*. Hamburg Aerospace Lecture Series, HAW Hamburg, 24.06.2021.
Available from: <https://doi.org/10.5281/zenodo.5356568>

© Copyright by Author, CC BY-NC-SA, <https://creativecommons.org/licenses/by-nc-sa/4.0>

